

# **BULK WATER METER TESTING AND VERIFICATION USING RESERVOIR VOLUMETRIC CHARACTERISTICS**



Report to the  
**Water Research Commission**

by

**M van Dijk & G Weststrate**  
Department of Civil Engineering  
University of Pretoria

**WRC Report No 3174/1/24**  
**ISBN 978-0-6392-0667-7**

**November 2024**



UNIVERSITEIT VAN PRETORIA  
UNIVERSITY OF PRETORIA  
YUNIBESITHI YA PRETORIA

**Obtainable from**

Water Research Commission  
Bloukrans Building, Lynnwood Bridge Office Park  
4 Daventry Street  
Lynnwood Manor  
PRETORIA

[hendrickm@wrc.org.za](mailto:hendrickm@wrc.org.za) or download from [www.wc.org.za](http://www.wc.org.za)

This is the final report of project no. C2020/2021-00232.

**DISCLAIMER**

This report has been reviewed by the Water Research Commission (WRC) and approved for publication. Approval does not signify that the contents necessarily reflect the views and policies of the WRC, nor does mention of trade names or commercial products constitute endorsement or recommendation for use.

# **BULK WATER METER TESTING AND VERIFICATION USING RESERVOIR VOLUMETRIC CHARACTERISTICS**

## **EXECUTIVE SUMMARY**

Water utilities in developing countries face significant challenges, with high levels of water losses posing a threat to financial sustainability. These losses, categorized as real and apparent, are exacerbated by metering inefficiencies and other factors like leakage and billing errors. Despite the adoption of universal and sub-metering systems, the benefits remain elusive due to meter inaccuracies, particularly in developing countries with poorly managed networks.

The urgency to control water losses is driven by recent droughts and increasing demand, necessitating effective distribution system management. Reservoirs, key components in water distribution, experience losses due to leakages and overflows, highlighting the need for quantification and remedial methods to address unaccounted for water (UFW) or non-revenue water (NRW).

Meter calibration and verification is crucial to minimize inaccuracies and optimize revenue collection. However, calibration procedures are often costly and disruptive, necessitating a strategic approach to determine calibration needs and intervals.

This study aimed to address these challenges by identifying optimal methods for determining reservoir volumetric characteristics, quantifying water losses, developing an innovative testing method for bulk water meters, and raising awareness about water loss issues. The literature review underscores the importance of accurate metering in managing water resources, identifying losses, and making informed decisions. Challenges in water loss reduction programs include poor design, incomplete implementation, and underestimation of difficulties. Successful interventions require a systematic approach tailored to the specific problems of each water supply system, emphasizing the importance of quantifying water loss to guide remedial actions.

Water metering is crucial for measuring water usage accurately. Meters come in various types, including mechanical (volumetric, inferential, and combination meters), electromagnetic, and ultrasonic, each with distinct features and applications.

Each meter type has advantages and limitations, making them suitable for different applications based on factors such as accuracy requirements, flow conditions, and water quality. Understanding these distinctions is essential for selecting the appropriate meter for specific water management needs.



Meter applications in water utilities are vital for accurate billing and monitoring. They are strategically placed throughout the supply and distribution infrastructure to measure various points such as raw water withdrawals, clean water production, connection points, and consumer usage. Installation considerations include complying with manufacturer recommendations, ensuring proper flow direction, and maintaining water supply.

Meter calibration is crucial for confirming performance, quality control, and compliance with legal requirements. Various methods such as gravimetric, volumetric and master meters are used for calibration. Testing methods include laboratory and in-situ verification. In-situ methods like master or reference meters, tracer methods, and on-site volumetric or gravimetric methods offer practical solutions for verifying meter accuracy in the field. Despite limitations in field testing accuracy compared to laboratory calibration, in-situ verification remains an important aspect of water meter management and maintenance.

The Water Meter Calibration Using Reservoir Volumetric Characteristics (WMCURVC) procedure is proposed, which follows defined steps like defining reservoir volumetric characteristics, installing measuring devices, conducting a step-by-step method to test flow through the meter and analysing the data. The process involves systematically filling or emptying the reservoir, for specific time periods, at different flow rates and measuring the volumetric change and comparing this with the flow meter readings for these periods.

The Volumetric Evaluation Tool offers a systematic approach for assessing the accuracy of in-situ flow meters using various measuring instruments. It guides users through a step-by-step process, starting with project definition, site selection, defining key parameters such as reservoir characteristics, site accessibility, flow meter functionality, and storage structures to ensure accurate verification. Reservoir volumetric characterization involves inputting parameters such as capacity, diameter, internal columns, and minimum operating and full supply level to calculate net volume at incremental heights. Flow meter characterization follows SANS 1529-4:2004 guidelines, determining error envelopes based on meter description, diameter, number, and class. The financial model assesses the economic impact of inaccurate flow meters, allowing users to define revenue generation parameters and potential revenue loss due to meter inaccuracies. Remedial action costs and payback periods are calculated, aiding utilities in decision-making.

It is important to highlight that the testing procedure determines the potential error that results from the meter and meter installation configuration. As many meters are not installed according to the manufacturers or local authorities' specifications the error in measurement can only be attributed to the system and not necessarily directly to the meter inaccuracy.



The Pierre van Ryneveld Reservoir complex in the City of Tshwane served as a case study, highlighting the importance of functional water meters, the installation configuration, reservoir storage characteristics, and appropriate testing equipment installation. The analyses indicated a possible 2.99% to 4.22% difference in measured inflow depending on the flow rate in which the existing flow meter overestimated the actual volume. Based on the average supply to this reservoir complex of R4.1 million litres per annum and a typical tariff of R14.58/m<sup>3</sup> the inaccuracy of on average 4.22% (high flow rate range) could equate to an amount of R2.54 million/annum. This potential saving in expenditure could be achieved if the installation configuration is optimized and a more accurate flow meter is utilized.

In conclusion, effective metering, quantification of losses, and strategic interventions are essential to mitigate water losses, enhance revenue collection, and ensure sustainable water management in developing countries like South Africa. The WMCURVC procedure simplifies the process although providing a comprehensive approach that could be used to test an installation and assess flow meter installation accuracy. Using the Volumetric Evaluation Tool offers a systematic approach for assessing the accuracy of in-situ flow meter installations and determining the potential economic impact.

This study contributes to knowledge gaps in sustainable water management, particularly in quantifying reservoir losses and in-situ verification of water meter installations, thereby enhancing water resource accountability.

## ACKNOWLEDGEMENTS

The research presented in this report emanated from a study funded by the Water Research Commission (WRC) whose support is acknowledged with gratitude.

We are grateful for the contributions by the following people:

Mr JN Bhagwan	:	Water Research Commission (Executive Manager)
Mr N Kubayi	:	Water Research Commission (Project coordinator)
Mr D Kgwale	:	Johannesburg Water
Prof K Wall	:	University of Pretoria
Mr B Rochecouste Collet	:	Tembo Power Holdings
Mr T Rasikhanya	:	Department of Water and Sanitation
Prof A Ilemobade	:	University of the Witwatersrand
Mr M Ncube	:	University of the Witwatersrand
Mr W Wegelin	:	WRP Consulting Engineers
Ms L Newton	:	City of Tshwane
Mr L Sebata	:	City of Tshwane
Mr T Westman	:	City of Tshwane
Mr J Nakene	:	City of Tshwane
Mr L Lekubu	:	City of Tshwane
Mr D Pillay	:	LTM Energy

We also acknowledge with thanks the inputs made by a number of students (Miss Z Mahlangu, Miss M Kasvova, Miss M Chitsungo, Mr J Sales, Mr RE Schroeder and Mr G Westrate) from the University of Pretoria, who conducted field work and assisted in compiling this report.



## TABLE OF CONTENTS

EXECUTIVE SUMMARY.....	iii
ACKNOWLEDGEMENTS.....	vi
TABLE OF CONTENTS.....	vii
LIST OF FIGURE.....	ix
LIST OF TABLES.....	xi
APPENDIX.....	A-1
1. INTRODUCTION.....	1
2. PROJECT AIMS.....	4
3. LITERATURE REVIEW.....	5
3.1 Background.....	5
3.2 Meters .....	7
3.2.1 Types of Water Meters.....	8
3.2.2 Meter Accuracy.....	23
3.2.3 Meter Applications.....	28
3.2.4 Meter Selection.....	32
3.2.5 Meter Installations .....	34
3.3 Meter Calibration.....	36
3.3.1 Legislation .....	37
3.3.2 Standards .....	37
3.3.3 Testing.....	38
3.4 Reservoirs.....	41
3.4.1 Types of typical reservoirs.....	41
3.4.2 Reservoir Water Level Measurement.....	42
4. METHODOLOGY.....	45
4.1 Measuring equipment.....	45
4.1.1 Flow meters .....	45
4.1.2 Reservoir level meters.....	45
4.2 Methodology.....	45
5. TEST SETUP AND LAYOUT.....	47
5.1 SITE SELECTION CRITERIA.....	48
5.2 TESTING PROCEDURE.....	51



6.	IMPLEMENTATION .....	52
6.1	PHASE 1: SITE SELECTION .....	52
6.2	PHASE 2: FIELD MEASUREMENTS.....	57
6.2.1	Site layout .....	57
6.2.2	Chamber components .....	60
6.2.3	Test procedure.....	60
6.2.4	Testing.....	66
6.3	PHASE 3: DATA ANALYSES.....	78
6.3.1	Data analyses – Test 1 - Inlet flow meter - C-FM (407).....	78
6.3.2	Data analyses – Test 2 - Inlet flow meter - A-FM (128) .....	80
7.	VOLUMETRIC EVALUATION TOOL .....	83
7.1	PROJECT DEFINITION .....	83
7.2	SITE SELECTION .....	84
7.3	RESERVOIR VOLUMETRIC CHARACTERISATION .....	85
7.4	FLOW METER CHARACTERISATION .....	86
7.5	DATA MEASURING.....	87
7.6	RESERVOIR LEVEL MEASURING .....	88
7.6.1	Logging frequency .....	88
7.6.2	Level logging.....	89
7.7	PRESSURE MEASUREMENTS.....	90
7.8	Ultrasonic flow measuring.....	90
7.9	MANUAL READINGS.....	91
7.10	FLOW METER VERIFICATION.....	92
7.11	FINANCIAL MODEL .....	93
8.	CONCLUSIONS .....	95
9.	REFERENCES.....	98
	APPENDIX.....	A-1





## LIST OF FIGURES

Figure 3-1: Types of Water Meters (Li & Chong, 2019) .....	9
Figure 3-2: An Example of a Mechanical Meter (Azo Materials, 2018).....	10
Figure 3-3: Single Jet Meter (Li & Chong, 2019) .....	11
Figure 3-4: Multi Jet Meter (Li & Chong, 2019).....	12
Figure 3-5: Vertical Woltman Meter (Zenner, 2004) .....	14
Figure 3-6: Horizontal Woltman Meter (Zenner, 2004) .....	14
Figure 3-7: Turbulence caused by successive bends in different planes (IHE Delft, 2013) .....	15
Figure 3-8: Horizontal Woltman Installed Horizontally .....	16
Figure 3-9: Horizontal Woltman Installed Vertically.....	17
Figure 3-10: Vertical Woltman Installed Horizontally .....	17
Figure 3-11: Combination Meter (Betta et al., 2002) .....	18
Figure 3-12: Modern Combination Meter with Removable Measuring Insert (Zenner, 2004).....	19
Figure 3-13: Electromagnetic Meter Operating Principle (Frenzel, 2011) .....	20
Figure 3-14: Transit-time Ultrasonic Meter (Azo Materials, 2018) .....	21
Figure 3-15: Doppler Ultrasonic Meter (Zuzunaga & Maron, 2013).....	22
Figure 3-16: Typical Error Curves and MPE Envelopes (Ncube & Akpofure, 2019) .....	25
Figure 3-17: Turbulence caused by bend or obstruction (IHE Delft, 2013) .....	26
Figure 3-18: Meter Application Points in a Distribution System (van Zyl, 2011).....	29
Figure 3-19: Basic Meter Selection Guide (Frenzel, 2011) .....	34
Figure 5-1: Test setup .....	47
Figure 5-2: Site selection process.....	49
Figure 5-3: Test procedure.....	51
Figure 6-1: Reservoirs and bulk pipelines in Tshwane WDS.....	52
Figure 6-2: Location of Pierre van Ryneveld Reservoir .....	53
Figure 6-3: Layout of pipe system at old reservoir.....	54
Figure 6-4: Plan view of bulk water pipe connecting reservoir to Rand Water (IMQS, 2011).....	55
Figure 6-5: Construction of new reservoir.....	55
Figure 6-6: In and outlet pipes (bottom of reservoir) .....	56
Figure 6-7: Site layout – Pierre van Ryneveld complex .....	58
Figure 6-8: Chamber detail – Pierre van Ryneveld.....	59
Figure 6-9: Component description.....	60
Figure 6-10: Testing procedure - Start/End (all valves open) .....	62
Figure 6-11: Testing procedure - Steps 1 and 2.....	63
Figure 6-12: Testing procedure - Steps 3 and 4.....	63
Figure 6-13: Testing procedure - Steps 5 and 6.....	65
Figure 6-14: HOBO U30 GSM logger with battery charger .....	73
Figure 6-15: HOBO U20 Water Level Logger 9 m.....	74
Figure 6-16: Pressure transducers.....	75



Figure 6-17: Ultrasonic flow meter.....	76
Figure 6-18: Inlet flow meter - C-FM (407) .....	76
Figure 6-19: Pressure transducer measuring water level in reservoir .....	77
Figure 6-20: Ultrasonic flow meter installed in Chamber C on inlet pipeline for additional verification of flow meter C-FM (407) .....	77
Figure 6-21: Average flow rate Test 1 - Run 1 (Low flows) .....	78
Figure 6-22: Average flow rate Test 1 - Run 1 (Average flows) .....	79
Figure 6-23: Average flow rate Test 1 - Run 1 (High flows).....	79
Figure 6-24: Differences in flow rates (Volumetric versus C-FM (407)) .....	80
Figure 6-25: Average flow rate Test 2 - Run 1 (Low flows) .....	80
Figure 6-26: Average flow rate Test 2 - Run 1 (Average flows) .....	81
Figure 6-27: Differences in flow rates (Volumetric versus A-FM (128)) .....	82
Figure 7-1: Project definition .....	83
Figure 7-2: Site selection process diagram.....	84
Figure 7-3: Flow meter verification guide.....	85
Figure 7-4: Reservoir volumetric characterisation .....	86
Figure 7-5: SANS 1529-4 flow requirements and flow meter characterisations.....	86
Figure 7-6: Typical error envelope .....	87
Figure 7-7: Flow meter description .....	87
Figure 7-8: Required level logging frequency.....	88
Figure 7-9: Error notification.....	89
Figure 7-10: Level logging analyses.....	89
Figure 7-11: Pressure logging analyses.....	90
Figure 7-12: Ultrasonic flow analyses.....	91
Figure 7-13: Manual in-situ flow logging.....	92
Figure 7-14: Flow meter verification .....	92
Figure 7-15:Flow meter revenue status.....	93
Figure 7-16: Remedial action CAPEX and Payback period .....	94



## LIST OF TABLES

Table 3-1: Typical advantages and disadvantages for meter applications.....	29
Table 3-2: Meter Application Criteria .....	31
Table 3-3: General Installation Configurations (Ministry of Housing and Urban Affairs, 2020).....	36
Table 3-4: Typical storage reservoirs and internal support structures .....	41
Table 3-5: Direct Reservoir Level Measurement Methods .....	43
Table 3-6: Inferential Reservoir Level Measurement Methods .....	44
Table 4-1: Diagram of the proposed Water Meter Calibration Using Reservoir Volumetric Characteristics process flow .....	46
Table 5-1: Measured components .....	48
Table 5-2: Site selection criteria .....	49
Table 5-3: Test procedure considerations .....	50
Table 6-1: Application of site selection criteria – Pierre van Ryneveld reservoir complex .....	57
Table 6-2: Chamber detail .....	60
Table 6-3: Test procedure .....	61



## APPENDIX

Appendix A-1: Pierre van Ryneveld Reservoir Complex – Test setup..... A-1



# **BULK WATER METER TESTING AND VERIFICATION USING RESERVOIR VOLUMETRIC CHARACTERISTICS**

## **1. INTRODUCTION**

High levels of water losses (25 to 50%) in distribution systems are the main challenge that water utilities in developing countries currently face. The water meter is an essential tool for both the utility and the customers to measure and monitor consumption. When metering is inefficient the financial sustainability of utilities is at stake. Apparent water losses caused by metering inefficiencies can be reduced by assessing meters' performance and identifying the main causes of inefficiency.

Water losses in the distribution system are categorised as either real losses (leakage) or apparent (commercial) losses. Apparent losses occur due to illegal use, inaccuracies in metering, meter reading errors, data handling and billing errors, and have a negative impact on utility revenue and accuracy of water usage data.

One of the tools that has received considerable attention in urban water demand management is universal metering. Universal metering refers to systems where meters have been installed on all properties and billing is based on the volume of water used rather than on flat rate (or non-metered) billing. Sub-metering has also been widely used as a tool to promote water conservation, notably in the USA. Water use reduction in the range of 10 to 30% has been reported as a result of sub-metering. The term 'sub-metering' refers to any metering that occurs downstream of a water utility's master meter to measure individual resident water usage in apartments, condominiums, mobile home parks, and small mixed commercial properties. However, universal metering and sub-metering has not brought the much anticipated benefits to water utilities in developing countries, most likely due to metering inefficiencies.

In water distribution systems a huge amount of water is lost while in transit to customers. The need to control water losses in municipal distribution systems has become more urgent in recent years due to water shortages caused by recent drought and an increase in water demand and cost burdens to accessing the water. To achieve continuous water supply, municipalities must ensure that their distribution systems become more effective and efficient by controlling losses. The main objective of a distribution system is to supply the total input volume of water to the customers at adequate pressure in sufficient amounts and achieve continuity and maximum coverage at affordable cost.

Input volume of water in a water supply system can be divided into either authorised consumption or water losses. Water losses are encountered all over the water supply system and an ability to quantify them opens an opportunity to possibly identify and rectify those losses.



In reservoirs specifically, water losses occur due to leakages and/or overflows. An ability to quantify either the leakage or overflow at a reservoir could help develop remedial methods that target the reduction of unaccounted for water (UFW) or non-revenue water (NRW). High levels of UFW are detrimental to the financial viability of water utilities, as well to the quality of water itself.

NRW or UFW is water that has been produced and is “lost” before it reaches the customer resulting and one of the reasons are from meter inaccuracies and poor water meter management which can be reduced by assessing meters' performance and identifying the main causes of malfunction.

Unfortunately, it is now widely acknowledged that mechanical water meter's metrology becomes more and more inaccurate during their operating life due to 'wear and tear' of the measuring components. However, most studies carried out on metering have been based on water utilities of developed countries, with well-managed water distribution networks, notably the USA, Spain, France, and Italy. Water meter performance in water systems of the developing countries, often with poorly managed networks and relatively lower water quality in the distribution system, is not very well understood.

These kinds of procedures are often expensive and as indicated they sometimes require a lot of operational disturbances in order to remove meters and move them to test beds and determine the accuracy. The calibration of a meter applies to that meter only, operating under the conditions with which it was calibrated. If in service these conditions are changed the calibration may not apply. In investigating meter calibration, there are aspects that have to be considered regardless of the type of meter to be investigated, namely:

- *Rate, quantity and time*  
The extent to which a flow measurement device is affected by the conditions of use is most often a function of the flow rate. It is therefore important that calibration takes place across a range of flow rates to establish this relationship. The mechanism by which a flow measurement device gives a reading of flow is dynamic. The sensor reacts to the flow of fluid through it or past it to realise an output related to the flow rate or the quantity passing. Measurement of flow rate and quantity are related through the time interval across which the quantity is measured.
- *Repeatability and reproducibility*  
To obtain confidence in a measurement it is expected that the measurement should be able to be repeated and give the same result.
- *Resolution*  
Although it may seem obvious, the resolution of the device must be adequate to allow a calibration to match the uncertainty required.

Therefore to be able to identify the need for calibration eliminates inaccuracies sooner but also helps plan meter calibrations better to minimize operational disturbances and also to quantify as much of the revenue water as possible.

It would therefore be ideal to develop an operational approach that can help determine the need for calibration of water meters since there is no absolute industry standard or third party (regulator or trading partner) that dictates the calibration frequency. In this case the meter is calibrated whether it requires it or not and is often assumed accurate between calibrations. For most applications however, it is the user who must define the calibration interval and the policy to determine when to calibrate.

The calibration interval should be chosen to minimise the risk of an incorrect meter reading making a significant impact on the process.



## 2. PROJECT AIMS

The aims of this project are:

- Identify the best way of determining the volumetric characteristics of reservoirs.
- Quantification of water loss at typical reservoirs and ways to evaluate and determine remedial actions.
- Defining of a method to calibrate bulk water meters at reservoirs utilizing the variation in water levels and the reservoir volumetric characteristics.
- Raising awareness on water losses at reservoirs and errors in water balances around reservoirs.





### **3. LITERATURE REVIEW**

#### **3.1 Background**

There is a range of projects in place to help maintain a sufficient supply of good quality water to meet South Africa's needs. The sector faces a set of two key challenges:

- loss of water caused by leaks, broken infrastructure and billing system failure
- lack of adequate skills to maintain the water infrastructure (Green Cape, 2014).

An example is made by looking at regional bulk water distribution. Water boards, municipalities and the DWS manage regional bulk water distribution. Water boards and some of the larger metropolitan municipalities are also responsible for purifying water to potable standards. Providing water services – which means water supply and sanitation – is the constitutional responsibility of local authorities such as metros, local or district municipalities. These local authorities act as Water Services Authorities (WSAs) and sometimes also as water service providers for all communities in their areas of jurisdiction. There are only 152 designated WSAs out of the 278 municipalities across the country (Ngabirano, 2017). It is therefore imperative to assist as much as possible on the first set of key challenges to offer possible long term solutions to the challenge of water loss.

Good quality water is an indispensable natural resource for the development of countries. At present, there is increasing worry over its conservation since demand has increased while the supply is decreasing (Constantine et al., 2017; Grafton, 2017). The solution to this situation could be either to increase the water supply or to reduce its consumption. In either case, it is necessary to obtain precise information on how much water enters the system and how much is consumed, which can be achieved by micro and macro water measurements (Palau et al., 2018).

Management of water resources in a system is related to the measurement of quantity of water available for supply and its effective usage. The management of water resources is indispensable for understanding the quantity of water being distributed in a system and its usage. Flow meters are used to measure the quantity of water entering into water supply systems, from different sources such as water works, water treatment plants, or bulk water suppliers, and water meters are used to measure the quantity of water that is delivered to each metered consumer in the system.

Metering therefore helps to better quantify the water produced and distributed through the concept of water balancing. A well-placed metering system in the water distribution network also assists in identifying where water loss /leakage could be encountered by comparing the water meter readings at the start of the system with the readings at the consumer end.



The data obtained from metering also allows water utilities to make decisions on capital investments, maintenance, staffing, and various other aspects of water supply systems. Therefore, water metering is an excellent application of the principle “to measure, is to know”. The knowledge of how much water is being used in the water distribution system is one of the keys in controlling water loss and revenue loss.

In dealing with water losses, a municipality has to compromise between the cost of reducing water loss and maintenance of a distribution system and the cost of water saved. Municipalities in South Africa struggle with revenue collection of water and often face huge debt pressure for the acquisition of water. The ability to quantify as much of the water loss in as many stages of the water supply system would help municipalities determine the low hanging fruit in their remedial actions towards acceptable water loss. Revenue collection can at times be a political endeavour that makes it hard to tackle, this leaves minimisation of water losses a more tangible approach that a municipality can control.

Water loss reduction programs tend to fail due to numerous reasons such as:

1. Poor design.
2. Diagnoses based on preconceptions rather than experimentation.
3. Partial implementation.
4. Failure to mobilize the necessary human and financial resources.
5. Lack of coordination between the components of the program.
6. Underestimation of the difficulties.
7. Underestimation of the time factor.

Therefore, there is no single water loss management intervention that will always provide the best savings at the least cost. Every water supply system is unique in some way and will have its own specific problems that set it apart from other systems. In reality, reducing water losses from municipal water distribution systems is not complicated, but does require a dedicated and methodical approach if real and sustainable savings are to be achieved. It is often similar to detective work where the first step in the process is to identify and understand the problem before trying to solve it. Too often, water loss reduction interventions are introduced which are inappropriate to the problems experienced in the reticulation system. The interventions must be selected to address the most serious problems experienced in a specific area to have any chance of success.

The key issue is to decide which interventions are the most appropriate to a specific area and how best to implement them. The most common mistake made by many municipalities is to believe that water loss reduction is achieved through only leak detection and repair. In such cases, large budgets are often used to search for unreported leaks using the latest hi-tech and expensive equipment. If the water losses are due to inaccurate metering or even background leakage, the leak detection activities will yield little or no results.



Before embarking on any major water loss reduction intervention, it is therefore necessary to spend some time and effort to quantify the problems and try to identify the root causes of the water losses.

Regardless of the unique and varying water supply systems, an ability to quantify the water loss is necessary in order to determine the remedial action that begin to address the water loss.

The reasons and priorities to improve or adopt metering may vary with place and time. Buenfil (2005) asserts that in poor arid countries, with fast growing urban populations the priorities, in decreasing importance, may be:

- a. Water conservation. Compel people to consume less water through volumetric charges. The saved water may allow: extend the system, improve service standards or protect the environment.
- b. Cost recovery and financial soundness of the water company. Appropriate revenue for all expenses (water supply, sewerage, pluvial drainage or other services) and provision for future investments.
- c. Unaccounted for water reduction (clandestine connections and leakages) through better information on consumptions.
- d. Better data about demands and variations to improve operation and planning of the water system.

There usually are differences among the volumes supplied and those consumed. Logically in this comparison supply should be greater than real consumption, and their difference represents water losses, which require thorough investigation in order to keep them within reasonable limits.

Metering leads the water undertaker into efficient use of other resources (money, energy, infrastructure, etc.) and good service quality (Buenfil, 2005). Although for consumptive use, billing water consumed through metering is a clear and fair charging system. The drawbacks are that meter installation, up-keeping and reading demand good organization and represent significant costs, particularly when massive radical changes are required regarding the existing practices.

### **3.2 Meters**

Water metering is the practice of measuring water use. Water meters are devices designed to measure the rate of flow of a fluid moving past a certain point within a specific system, such as water moving through a pipe. Water meters have various synonymous, used in different cities, countries or circumstances. Some of these equivalent terms are volume counter, flow-gauging device, water totalizer, flowmeter, and accumulator. Various literature distinguishes between water meters and flow meters based on the measuring mechanisms used by the meter. However, in this study, the term water meters is used generically to refer to any type of water measuring device.



They are commonly used by water utilities, but also have uses in industrial and manufacturing capacities (Baker, 2016), (Li & Chong, 2019). The precise purpose often dictates which design is ideal. Knowing the quantity of water that is produced and distributed to different places and customers helps a water company to keep its account and make financial as well as technical analysis (Beardsley, 2017) and (IHE Delft, 2013).

Flow meters work using basic physical and hydraulic principles as the mass conservation or continuity principle, the energy conservation principle (head losses due to flow and velocity energy converted to position energy), momentum or inertia (Buenfil, 2005). Irrespective of the hydraulic principle used, Ministry of Housing and Urban Affairs (2020) and van Zyl (2011) assert that Water meters consist of four basic components:

- a sensor to detect the flow,
- transducer to transmit the flow signal,
- a counter to keep track of the total volume of water passed,
- an indicator to display the meter reading.

While the four basic components are always present in any water meter, many different types of devices are used for each component. There are also many additional components that may be installed on a water meter to perform specific functions. Thus, it is necessary to look at water meter types and applications in more detail.

### 3.2.1 Types of Water Meters

Urban utilities use and need water meters as tools for the proper management of a valuable resource, which is water. There exist numerous water meter types, with differences in design, material, size, precision, operating principle, reading display, purpose, and site where the meter is to be installed. Before entering in any technical detail about how meters work, it is important to review why meters are required. This will give insight into the convenient meter type for a given task. Water meters can be used either to measure the volumes supplied by the utility through different sources referred to as macro metering, or to know the volumes consumed by clients referred to as micro metering (Buenfil, 2005).

The first important distinction of water meters is based on the different mechanisms used by the water meter to measure the flow of water passing through it. These are mechanical water meter, electromagnetic water meter and ultrasonic water meter as shown in Figure 3-1 (Li & Chong, 2019). Mechanical meters have moving parts that detect the flow, such as a piston or impeller. Electromagnetic and ultrasonic meters have no moving parts, but detect the flow through the meter using electromagnetic principles or ultrasound waves. All these have different precision and manufacturing standards and are associated to distinct installation and operation costs, and, of course, will render distinct revenues to the water company.



Water meter classification could also be based on the usage. The two usage classifications are domestic or bulk. Mechanical meters make up the vast majority of meters used in water distribution systems (Ministry of Housing and Urban Affairs, 2020), (van Zyl, 2011). Water meters like the single jet, multi-jet, piston type, electromagnetic and ultrasonic meters are used for domestic purposes. Generally, Woltman water meters (mechanical type), electromagnetic and ultrasonic water meters are used for bulk metering. Ultrasonic and electromagnetic meters are only applied in special cases, such as in very large pipes or where a particularly high accuracy is required (van Zyl, 2011). The frequently used technologies for bulk flow meters, such as Woltman, volumetric valve, single-jet, tangential and proportional (Beardsley, 2017), (Betta et al., 2002), (Zhen & Tao, 2008).

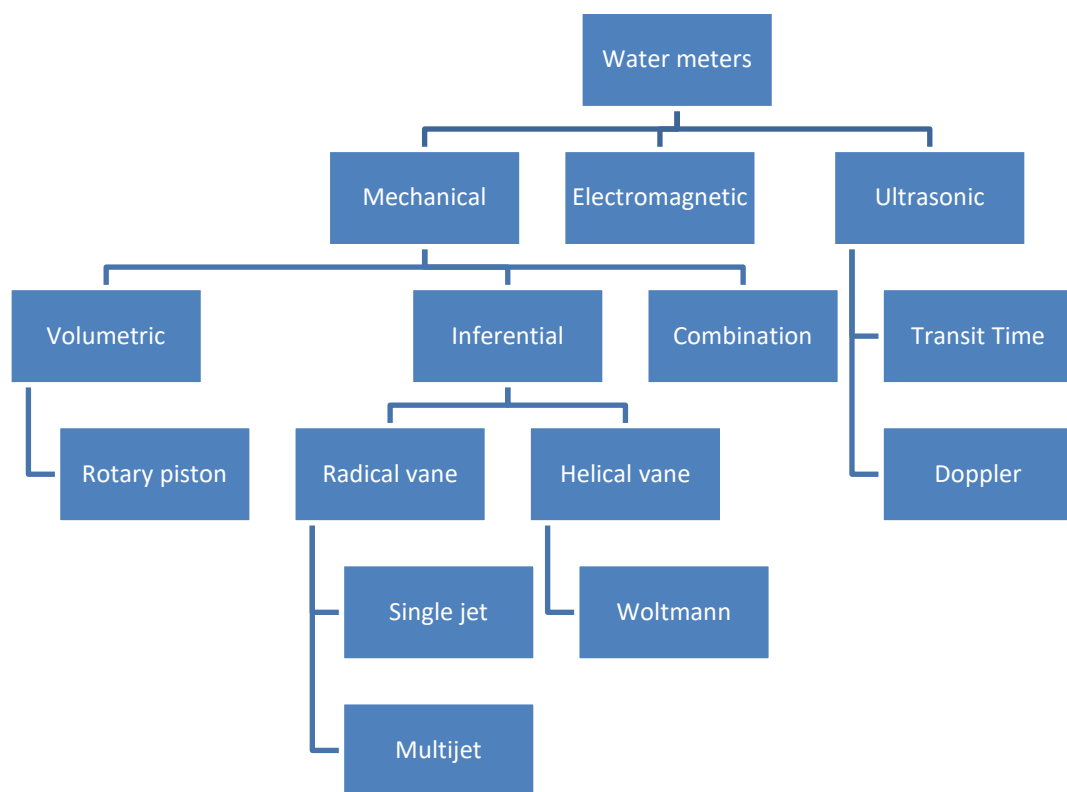

• **Figure 3-1: Types of Water Meters (Li & Chong, 2019)**

### 3.2.1.1 Mechanical Meters

Mechanical meters have moving parts that detect the flow, such as a piston or impeller. They are the most common and economical type of water meters used in water distribution systems. Mechanical water meters measure the rate of flow based on the movement of a specific element within the meters construction. The amount of movement recorded correlates to the amount of water that has flowed through that portion of the system (FlowMetrics Inc, 2017).



To be specific, mechanical flow meters work by measuring the speed of water that causes a piston or turbine to rotate as seen in Figure 3-2 (Azo Materials, 2018). The disadvantage of mechanical water flow meters for water measurement is that they may clog up when the water is dirty or contain larger particles, which leads to increased maintenance costs. Mechanical water meters also do not work well when the water flow is low. Mechanical meters are further classified using three categories namely:

- Volumetric
- Inferential
- Combination

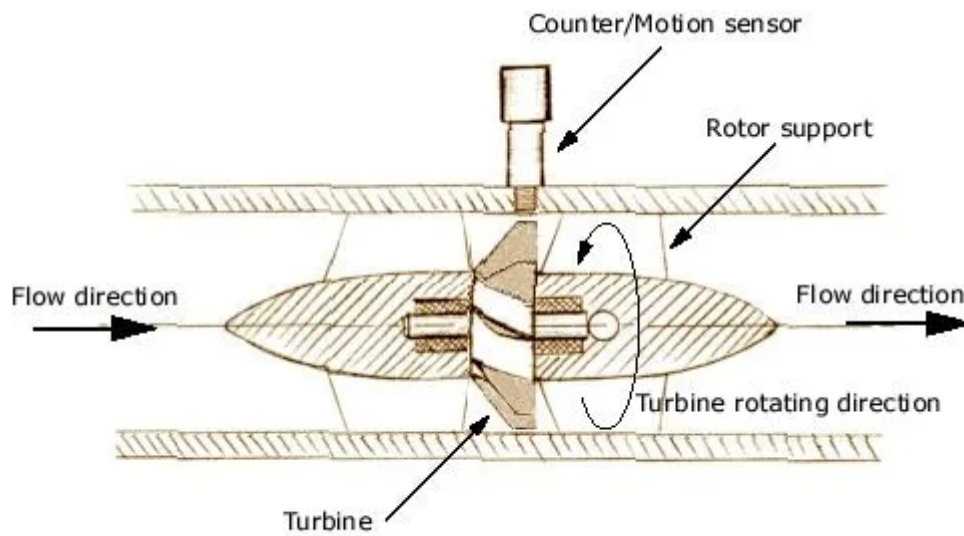

- **Figure 3-2: An Example of a Mechanical Meter (Azo Materials, 2018)**

#### 3.2.1.1.1 Volumetric

Volumetric meters directly measure the volume of flow passing through them. Most volumetric meters use a rotating disk to measure the flow and are known as rotating piston meters.

Rotary meters use a rotating cylindrical piston to directly measure the volume of flow passing through from the inlet to the outlet of the meter. The volumetric flow rate of the water is proportional to the rotational speed of the piston (Azo Materials, 2018).

Rotating piston meters are known for their accuracy, long life, and moderate cost. Rotating piston meters are sensitive to sand and/or other suspended solids in the water that get clogged between the piston and chamber wall, thereby clogged the meter. For application of rotary meters, the TDS level in water should be lower than 200 ppm (Ministry of Housing and Urban Affairs, 2020). These meters are also sensitive to low flows and are particularly suitable for applications where the water flow rates are low or where frequent on-site leakage occurs (van Zyl, 2011).



These meters are not suitable for systems where excessive pressure loss is not preferred as they are prone to relatively high-pressure losses. They often tend to be bulky and expensive than other meter types and are used for most domestic applications (American Water Works Association, 1962).

### 3.2.1.1.2 Inferential

Inferential meters do not measure the volume of water passing through them directly, but infer the volumetric flow rate from the velocity of the water (van Zyl, 2011).

Velocity water meters are also known as internal capacity meters. These meters are designed to determine the volume of water that has flowed through the meter based on the speed of the flow (FlowMetrics Inc, 2017).

There are two categories of inferential meters namely along with:

- Radial vane impeller
- Helical vane impeller

### Radial Vane

#### *Single Jet*

Single jet meters are inferential meters consisting of an impeller with radial vanes (also called a fan wheel) and use a single flow stream or jet to move the sensor as shown in Figure 3-3. The rotational speed of the impeller is converted into a flow rate, which is registered on the meter (Arregui et al., 2018), (Palau et al., 2018).

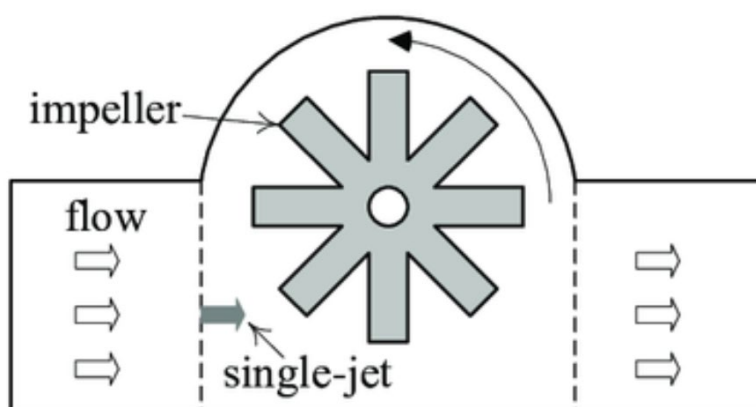

• **Figure 3-3: Single Jet Meter (Li & Chong, 2019)**

The single jet is not sensitive to a twisted flow profile and does not require an inlet straight pipe section. This is because the inlet nozzle and the turbine chamber have slightly converging shapes, therefore any distorted profiles can be corrected without seriously affecting their precision (Palau et al., 2018).



It is critical however to precisely control the path of water through the single jet meter to obtain accurate readings. Thus, the inside portion of the single jet meter has to be manufactured to strict tolerance.

The accuracy of single jet meters reduces due to wear in the moving parts with continuous usage over time. In particular, the starting flow and accuracy of metering at low flow rates may deteriorate, and thus older meters tend to under-register at low flow rates. At higher flow rates, the error can be positive or negative and is likely to be exaggerated through sediments or deposits accumulating inside the meter. Air moving through the meter will also be registered as water, and thus can lead to over-register of water flow (Larraona et al., 2008).

Developed for the very exact measuring of water amounts, especially in the starting flow range, combined with a wide load range, this meter type is best used for highly accurate measuring of strongly fluctuating flow rate amounts. This robust nature allows the meter to be installed in vertical and horizontal positions (Arregui et al., 2018).

### *Multi-jet*

The operation of Multi Jet meters is similar to that of single jet meters, except that Multi Jet meters use several jets to drive the impeller at multiple points as shown in Figure 3-4. The rotation of the impeller determines the amount of water that has passed through the meter. They normally use an internal bypass with a regulating screw to adjust the flow passing through the impeller (FlowMetrics Inc, 2017).

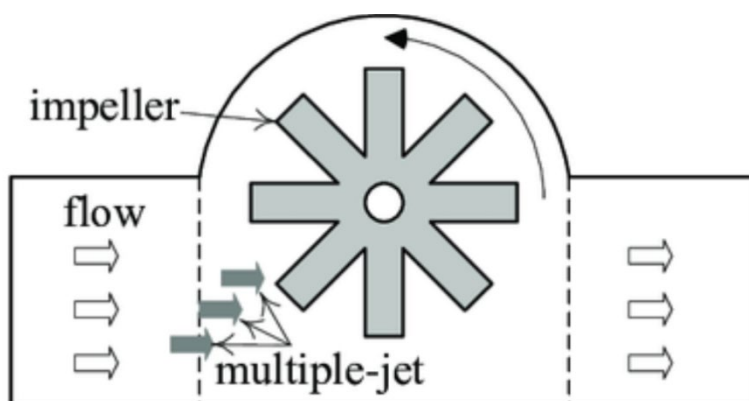

• **Figure 3-4: Multi Jet Meter (Li & Chong, 2019)**

Multi-jet meters are used when a high level of accuracy is required in a small space (FlowMetrics Inc, 2017).

Due to the use of several jets to drive the impeller at multiple points, this implies that the forces applied on the impeller are better balanced than in single jet meters, thereby reducing wear on the moving parts and provides greater durability.





The meters are not sensitive to the velocity profile in the pipe and are tolerant of small suspended solids in the water (Baker, 2016). This tolerance is due to the multi jet meter being fitted with removable strainers on the inlet side of the meter, to facilitate the cleaning of the same. A second internal strainer often covers the openings of the metering chamber. The internal strainer, if clogged, can affect the accuracy of the meter, thereby causing over registration of the flow. Multi-jet meters are also often bulkier than single jet meters. They also are not sensitive to low flow rates. Multi-jet meters are widely accepted where the water supply system is intermittent (Ministry of Housing and Urban Affairs, 2020).

## **Helical Vane**

### *Woltman*

The Woltman meter uses an impeller with helical vanes, which resembles a fan or boat's propeller. Woltman meters measure the velocity of the water flowing through with the help of the impellers often resembling a turbine. As water flows over the helical vanes, it causes the impeller to rotate. The volume is mechanically calculated, through the known volume of the measuring chamber, and indicated with the roller counters (Arregui et al., 2006).

There are two different types of Woltman meters, Vertical (WS) and Horizontal (WP). In the WS, the turbine shaft stands perpendicular to the axis of the pipeline. The water is deflected in an S-form and flows through the turbine from the bottom to the top as shown in Figure 3-5. The movement of the turbine can be directly transmitted without diversion to the dry dial counter. There is an advantage over the Parallel Woltman meters in the improved starting flow and during fluctuating flow rates (Zenner, 2004).



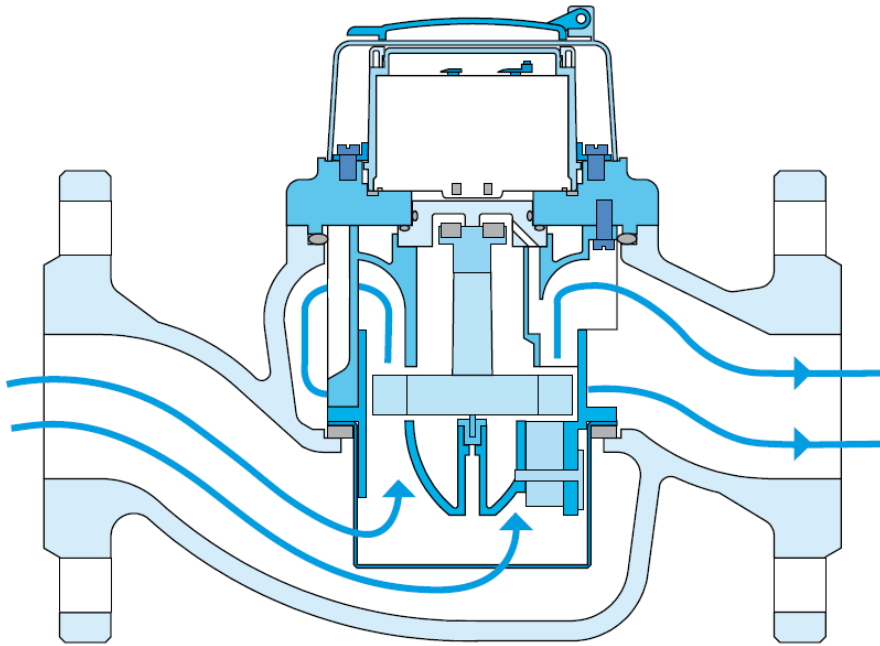

- **Figure 3-5: Vertical Woltman Meter (Zenner, 2004)**

In the Horizontal Woltman (WP) the turbine shaft is arranged parallel to the axis of the pipeline as shown in Figure 3-6. This means that the axle of the helical vane is parallel to the flow and the inlets and outlets are directly in line with the pipeline. Water flows directly through the meter with minimal disturbances by the meter body. The rotation of the turbine is transmitted through a worm gear to the dry dial counter (Arregui et al., 2006).

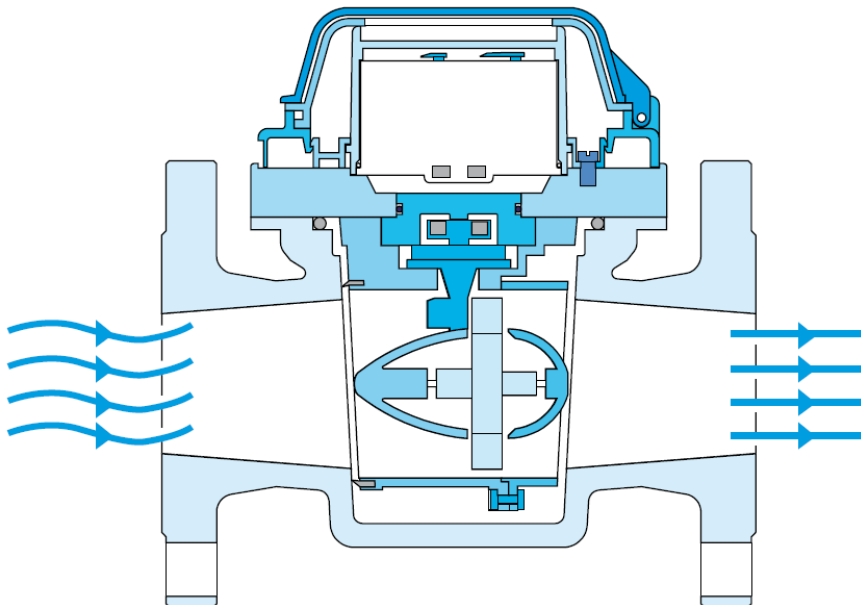

- **Figure 3-6: Horizontal Woltman Meter (Zenner, 2004)**



Turbine (Woltmann) meters can be less accurate than displacement or multi-jet meters, but provide a benefit in that they do not significantly impede the flow of water within a pipe. For higher flowrates, this means less pressure is lost based on the need to negotiate the meter (Palau et al., 2019). They are affected by flow distortions that may interfere with the flow of water through the meter. Bends or valves close to a Horizontal Woltman meter can affect the meter's accuracy. Turbulent flow, caused by two successive bends in different planes as shown in Figure 3-7, is particularly unfavourable for their accuracy.

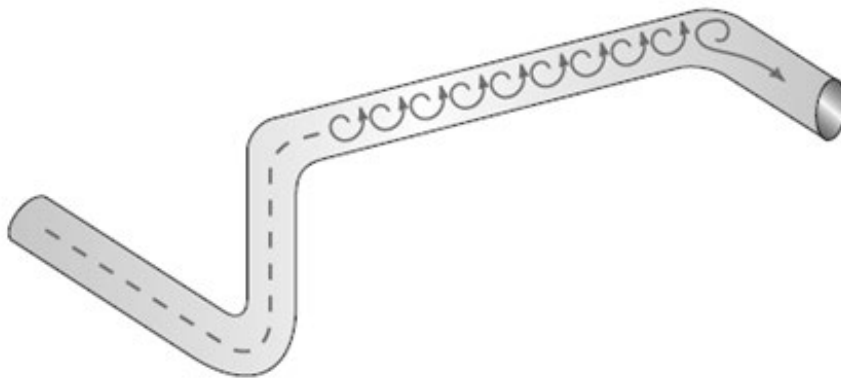

- **Figure 3-7: Turbulence caused by successive bends in different planes (IHE Delft, 2013)**

The unique form of the propellers enable the Woltman meters to cover a very large measuring range with especially low head loss. Due to their construction for high flow rates, Woltman type water meters can be used for flow rates higher than  $Q_n$  15 m<sup>3</sup>/h with minimal head loss (Zenner, 2004).

The vertical Woltman has an advantage over the Parallel Woltman meters in the improved starting flow and during fluctuating flow rates (Zenner, 2004). This is because the horizontal since the transducer needs to turn the circular movement of the impeller through a perpendicular direction to connect it to the counter, greater torque is required, which reduces the meter's sensitivity to low flows (Baker, 2016). Horizontal Woltman meters are always used when high flow rates with a relative constant flow rate profile are to be measured. Through its robust construction they not only are capable of covering a large measuring range, but the measuring accuracy is also long-term stable. The vertical Woltman meter supersedes the horizontal version during fluctuating flow rates. Since the turbine is arranged perpendicular to the pipe axis, there is no need for a direction change of the transmission through the worm gear to the counter.

The Woltmann meter is ideal for large commercial operations, as well as fire protection. They are also used as master meters within larger water distribution systems (Baker, 2016), (FlowMetrics Inc, 2017).



Horizontal Woltman meters can be installed horizontally and vertically as shown in Figure 3-8 and Figure 3-9 respectively. They can also be installed on inclined pipelines. For the best measuring results, the meter should be installed in horizontal a position with the counter facing upwards (Baker, 2016). The Vertical Woltman meters can only be installed horizontally so the counter must be facing upwards as shown in Figure 3-10. The overhead installation with the counter facing downwards is not admissible with any meter type.

The best measuring results can be achieved with all Woltman meters if some simple but important installation rules are followed. Woltman meters are by construction sensitive to the incident flow profile. Gate valves that are not completely opened within close proximity to the meter, influence the performance of the meter (Palau et al., 2019). Woltman meters must be operated in the correct flow direction with sufficient minimum straight pipe section strictly adhered to upstream of the meter. If a sufficient straight pipe section is not possible, then a honeycomb flow straightener should be installed (Baker, 2016). For improved performance of the meter, a sufficient straight pipe section should be present downstream of the meter.

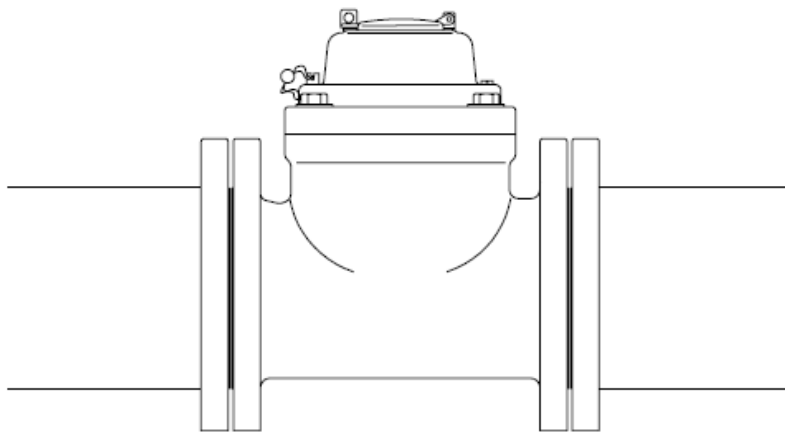

- **Figure 3-8: Horizontal Woltman Installed Horizontally**



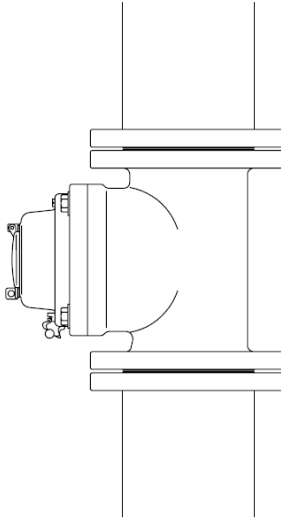

- **Figure 3-9: Horizontal Woltman Installed Vertically**

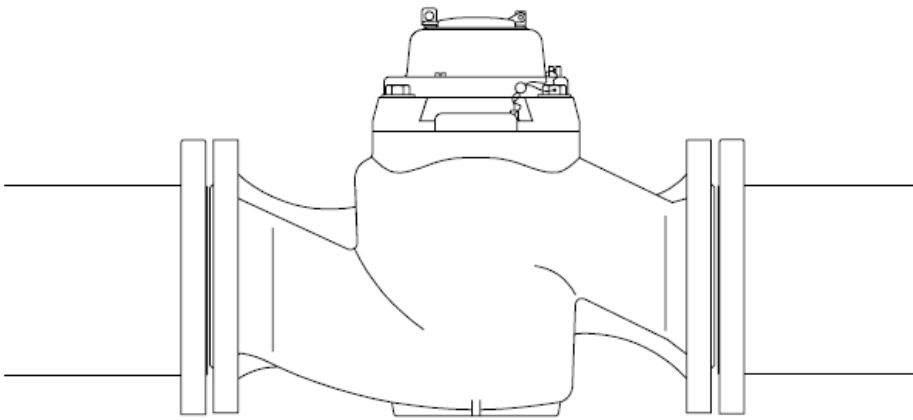

- **Figure 3-10: Vertical Woltman Installed Horizontally**

#### 3.2.1.1.3 Combination

A combination meter is composed of two water meters of different size. The components are usually a large meter, a small or by-pass meter and a changeover valve as seen in Figure 3-11 (Brandt et al., 2017). These components are arranged so as to form a single measurement device included in a flanged body meter. The meter will operate using only the small by-pass meter at low flow rates. If the flow rate increases above the switching point of the built in valve, the spring-loaded valve will then determine how the combination of meters will operate to account for the increased flow rate. Depending on the flowmeter's design, the spring-loaded valve will direct water through the combination meter in one of two ways:

- Through the by-pass meter at low flow rates, and then through the large meter only at higher flow rates
- Through the by-pass meter at low flow rates, and then through both meters at higher flowrates.



To determine the consumption, the counters on each meter need to be read individually and the individual consumptions added together (Zenner, 2004).

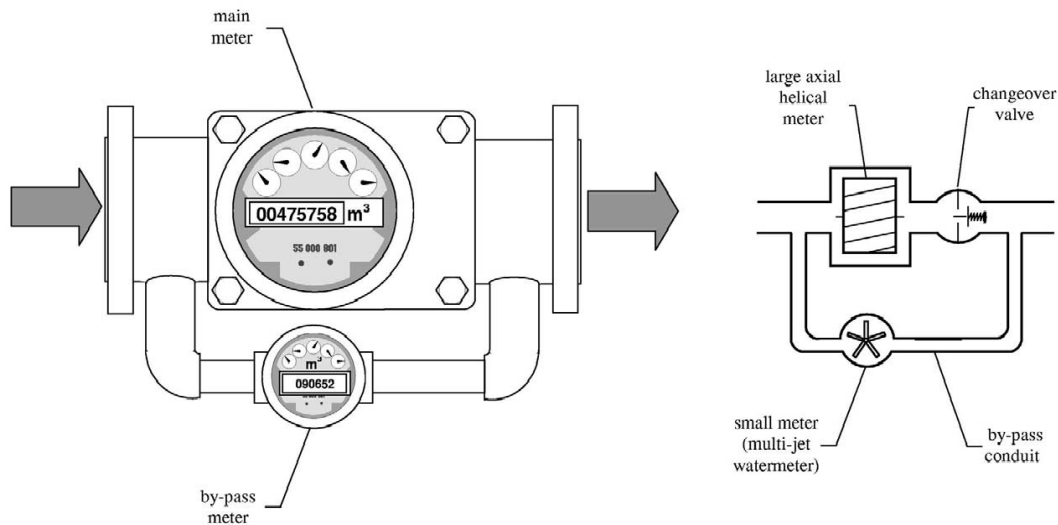

• **Figure 3-11: Combination Meter (Betta et al., 2002)**

Modern designs of the Compound water meter have the main meter, the secondary meter and the spring loaded valve all assembled on one plate. The advantage is that the meter body can remain in the piping during periodical replacement, and the calibrated measuring insert simply needs to be interchanged as seen in Figure 3-12. The main meter is designed as a horizontal Woltman and the secondary meter as a measuring cartridge.

Compound meters are designed to meet situations with highly variable needs, such as fluctuations in high flowrates and low rates of flow, but where accuracy is required in all circumstances. This allows for an extremely large measuring range can be covered with Compound water meters. Often, these meters feature traits of other meters that can be switched in-between based on need (FlowMetrics Inc, 2017). For example, in the case of a fire, a very high flow rate must be measured at a tap connection where under normal circumstances a domestic meter would be sufficient. In this operation case, the spring loaded valve opens and the main meter also measures the volume flowing through (van Zyl, 2011). This makes combination meters applicable for scenarios where high flowrates are experienced, but leak detection is also highly desired during flow conditions, reservoir metering being an example.

The Compound water meters can only be installed horizontally so the counter must be facing upwards. Typical locations for these are schools, homes, office buildings, or supply lines of smaller residential areas where the flow rate must be measured accurately during the night.

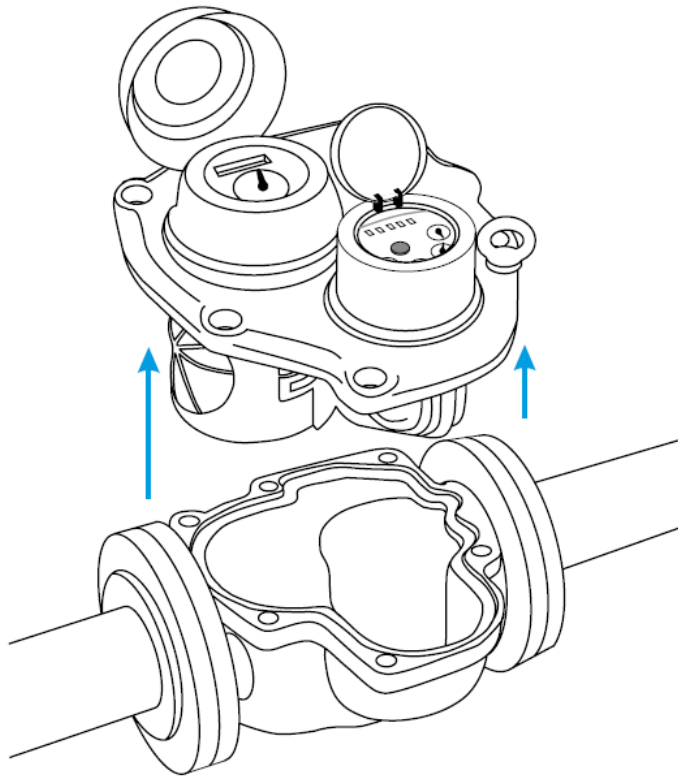

- **Figure 3-12: Modern Combination Meter with Removable Measuring Insert (Zenner, 2004)**

### 3.2.1.2 Electromagnetic Meters

Electromagnetic meters, also known as mag meters, are a variant of velocity-type water meters that have no moving parts but detect the flow through the meter using electromagnetic waves. This measure velocity using electromagnetic properties, instead of the flow through mechanical measurement mechanisms. Electromagnetic meters functions on the principle of electromagnetism, called Faraday's Induction Law as shown in Figure 3-13 (Baker, 2016). In an electromagnetic meter, a magnetic field is created across the pipe. When water, which is an electrical conductor, moves through the magnetic field, a voltage is induced which is detected by electrodes in the body of the meter. The voltage is directly proportional to the flow velocity, which allows the flow rate to be calculated (Pereira, 2009).



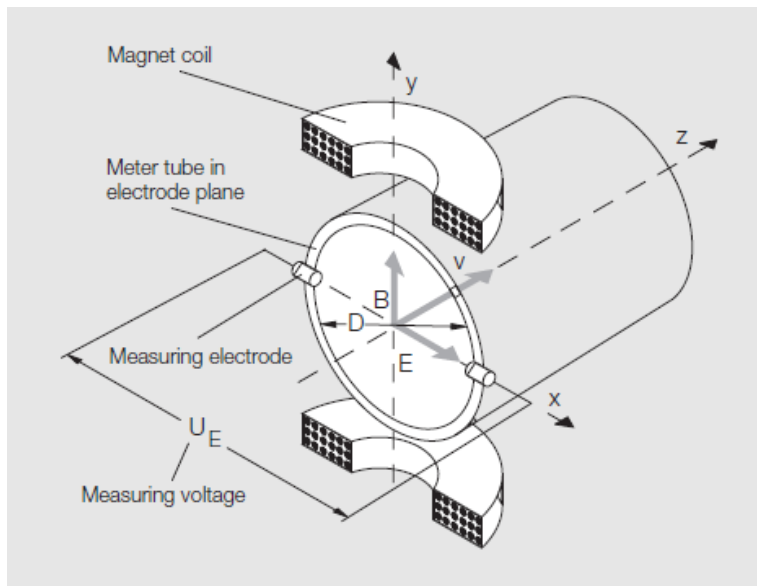

- **Figure 3-13: Electromagnetic Meter Operating Principle (Frenzel, 2011)**

Since electromagnetic meters do not rely on mechanical components to measure flow, they have the added benefit of being able to operate in either direction. Additionally, they can be ideal for situations where unfiltered water flow needs to be measured, as there is a limited risk of build-up harming the water meter. However, the presence of magnetic material can impact accuracy (FlowMetrics Inc, 2017). These meters are also susceptible to damage from lightning strikes if installed outside without canopy. Besides, the electromagnetic meters also need an electrical connection or batteries to operate (Ministry of Housing and Urban Affairs, 2020).

The electrodes of an electromagnetic meter should preferably be mounted on a vertical pipe, but since this is generally not possible, the meter should be mounted with the electrodes on the horizontal axis to avoid an electrode being situated in an air pocket at the top of the pipe.

Some meters have an additional sensor to detect empty pipe situations. On-site power or backup battery power is a necessity and it is possible to lose readings and volumetric totals if backup power is not available (Van Zyl, 2011).

This type of meter is increasingly being used in the water industry owing to zero head loss and good accuracy and reliability. They are mostly for bulk metering, such as in very large pipes and/or where high accuracy metering is required like with municipal water measurement (Frenzel, 2011), (Ministry of Housing and Urban Affairs, 2020).





### 3.2.1.3 Ultrasonic Meters

Ultrasonic meters have no moving parts but detect the flow through the meter using ultrasound waves. This is achieved by using ultrasonic transducers to send sound waves through the water to determine velocity. This is done by compensating for the known resistance associated with the meter's construction, as well as the impact of any piping (Baker, 2016). There are two types of ultrasonic meters depending on different working mechanisms namely Transit time meters and Doppler meters.

The transit-time method uses two opposing transducers which are mounted at an angle to the direction of flow as shown in Figure 3-14. The speed of sound from the upstream transducer to the downstream transducer represents the inherent speed of sound plus a contribution from the fluid velocity. A simultaneous measurement is taken in the opposite direction which represents the speed of sound minus the fluid velocity. The differences in the transit times of the signals is used to determine the flow velocity and flow rate (Brandt et al., 2017; Frenzel, 2011).

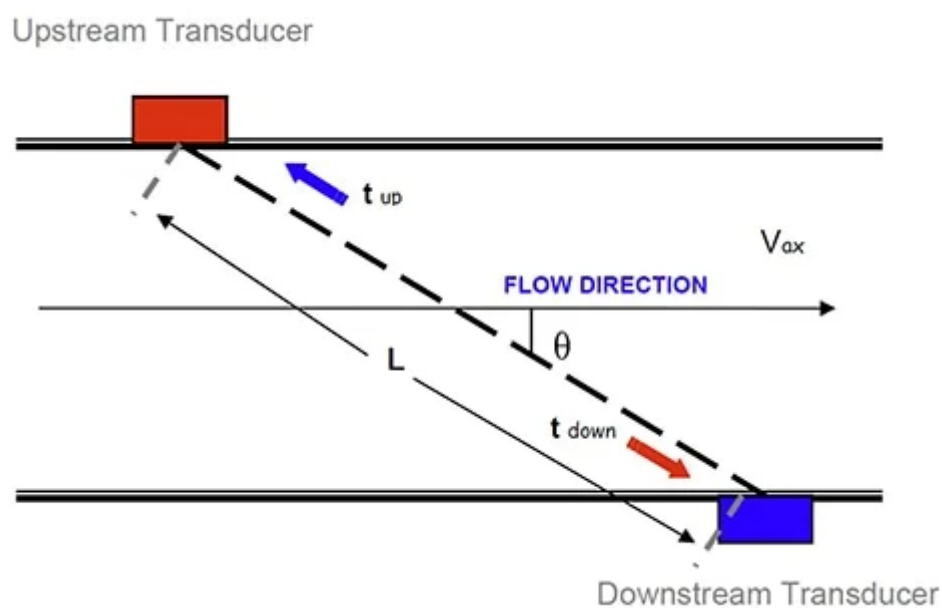

- **Figure 3-14: Transit-time Ultrasonic Meter (Azo Materials, 2018)**

Doppler ultrasonic water meter's function based on the Doppler Effect, which is the measure of the change in the frequency of a sound wave when it is reflected back from a moving object (Frenzel, 2011). This type of ultrasonic meter uses two transducers mounted in the same case on one side of the pipe. An ultrasonic sound wave of constant frequency is transmitted into the fluid by one transducer. Solids or bubbles within the fluid reflect the sound back to the receiver element and the change in the wave frequency is measured. This shift can then be related to the velocity and thus flow rate of the water (Brandt et al., 2017).



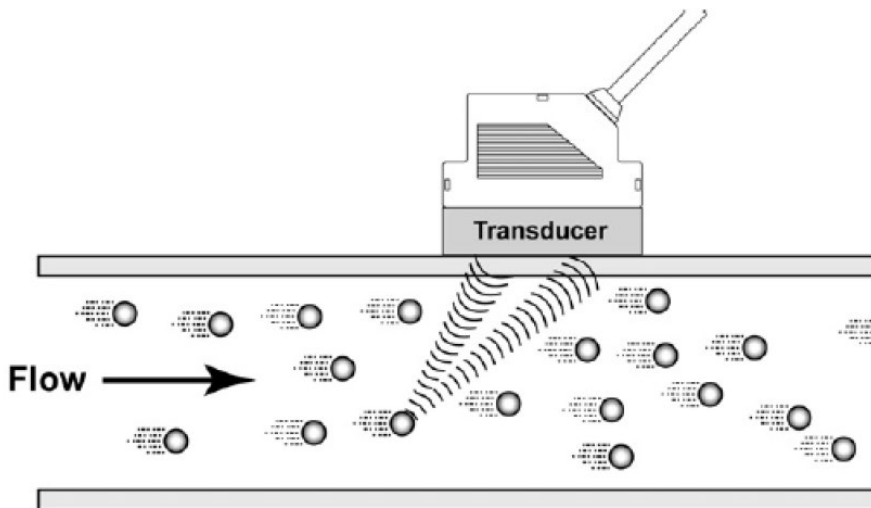

• **Figure 3-15: Doppler Ultrasonic Meter (Zuzunaga & Maron, 2013)**

Transit-time meters can use sound transducers that are clamped externally onto the walls of a pipe to provide portable non-intrusive flow measurement. Additionally, these clamp-on designs are often easier to maintain, since they are external devices (FlowMetrics Inc, 2017). Practically, they can be used on any pipe material including metals, plastics, fibre cement and lined or coated pipes. A disadvantage is that the ultrasonic pulses must traverse pipe walls and coatings, and therefore the thicknesses and acoustic properties of these elements must be known. Deposits on the inside pipe surface can affect signal strength and performance (Zuzunaga & Maron, 2013). Permanently installed transit time meters are often called wetted transducer meters since their sound transducers are in direct contact with the fluid (Ministry of Housing and Urban Affairs, 2020).

Transit-time type meters are reasonably accurate if installed and operated correctly. The pipe wall must be of a hard material that transmits sound well. Deteriorated and porous pipe linings and deposits are likely to affect the accuracy of ultrasonic flow measurement and may cause drift. Accuracy is adversely affected by transducer misalignment and vibrations in the system. In some cases, multi-beam devices are used to improve meter accuracy (van Zyl, 2011). Doppler meters are generally less accurate but are used for dirty water and water with air bubbles (Brandt et al., 2017).

The advantages of transit time flow meters include high accuracy and reliability, which makes them cost-effective for use in large pipes. The clamp-on version of the meter is easy to install without the need to shut down the pipe. However, transit time flow meters are sensitive to distortions in the velocity profile of a pipe, require an electricity supply, and are not suitable for dirty waters (FlowMetrics Inc, 2017). Transit time meters work better in clean fluids and thus are ideal for drinking water pipes. They are mostly for bulk metering, such as in very large pipes and/or where high accuracy metering is required like with municipal water measurement (Zuzunaga & Maron, 2013).



Doppler ultrasonic water meters can only be used for water that contains particles or air bubbles, and thus they are more suitable for dirty water applications such as raw water. They are also sensitive to disturbances in the velocity profile and require an electrical supply. While they are not suitable as billing meters, they can be cost-effective as flow monitors if measurement accuracy is not critical (Ministry of Housing and Urban Affairs, 2020).

### 3.2.2 Meter Accuracy

Metrology is the study of measurement accuracy, including how to determine the accuracy of a given measurement device and what sort of accuracy is required when measuring different things. Van Zyl (2011) further asserts that it is important to understand and correctly use the metrology terms when dealing with water meters and provides a quick definition guide for the relevant terms related to metrology:

- Actual volume,  $V_a$ : The total volume of water passing through the water meter, irrespective of how long this took.
- Indicated volume,  $V_i$ : The volume of water indicated by the meter. For a perfect meter, this will be equal to the actual volume. However, most meters will indicate slightly higher or lower readings.
- Error: The difference between the indicated volume and the actual volume, or  $V_i - V_a$ .
- Relative error: The error divided by the actual volume.
- Intrinsic error: The meter error determined under controlled conditions in a highly accurate testing laboratory accredited for this purpose.

Water meters, as most gauging devices, even when new, are not always exact and reliable. They have an appropriate working range where precision is high, and out of it, errors increase exponentially (Buenfil, 2005).

Almost all meter errors result in them under-reading: the meters will read less than the actual water volume being consumed. Consequently, a proportion of the consumed water is not billed to the customer – loss in revenue. IHE Delft (2013) provide possible causes of meter errors as:

- Incorrect sizing
- Their class
- Their condition:
  - Age
  - Water quality
  - Maintenance regime
- Incorrect installation
- Meter tampering



Water meters have a flow range over which they have been designed to operate. This range is bound by their minimum flow rate ( $q_{min}$ ) up to their maximum or overload flow rate ( $q_s$ ) (Johnson, 1999):

- $q_{min}$  is the lowest flow rate at which the meter is required to give indications within the permissible tolerance and is specified as a ratio of the permanent flow rate ( $q_p$ ) for various metrological classes of water meters.
- $q_p$  is the flow rate for which the meter is designed and at which the meter is required to give indications within the permissible tolerance under normal conditions of use.
- $q_s$  is the rate that is equal to  $2 q_p$  and also represents the highest flow rate at which the meter is required to operate in a satisfactory manner for a short period of time without deterioration. This short period of time is specified by some manufacturers as 24 h in the life of the meter.
- Between  $q_{min}$  and  $q_p$ , a transitional flow rate ( $q_t$ ) is specified dividing the flow range into two separate permissible tolerance zones.
- $q_t$  is also specified as a ratio of  $q_p$  for various metrological classes of water meters.

The maximum permissible error (MPE) of a meter is also outlined in the standards and can be positive or negative. This maximum permissible error envelope is divided into two zones namely the lower and upper zones, and SANS 1529 specifies a minimum permissible relative error of 5% in the lower zone, and 2% in the upper zone as shown in Figure 3-16 (Ngabirano, 2017). This must be ensured after every installation. However, meters in the field are capable of errors of up to 1.5 times those of the new ones (Van Zyl, 2011).



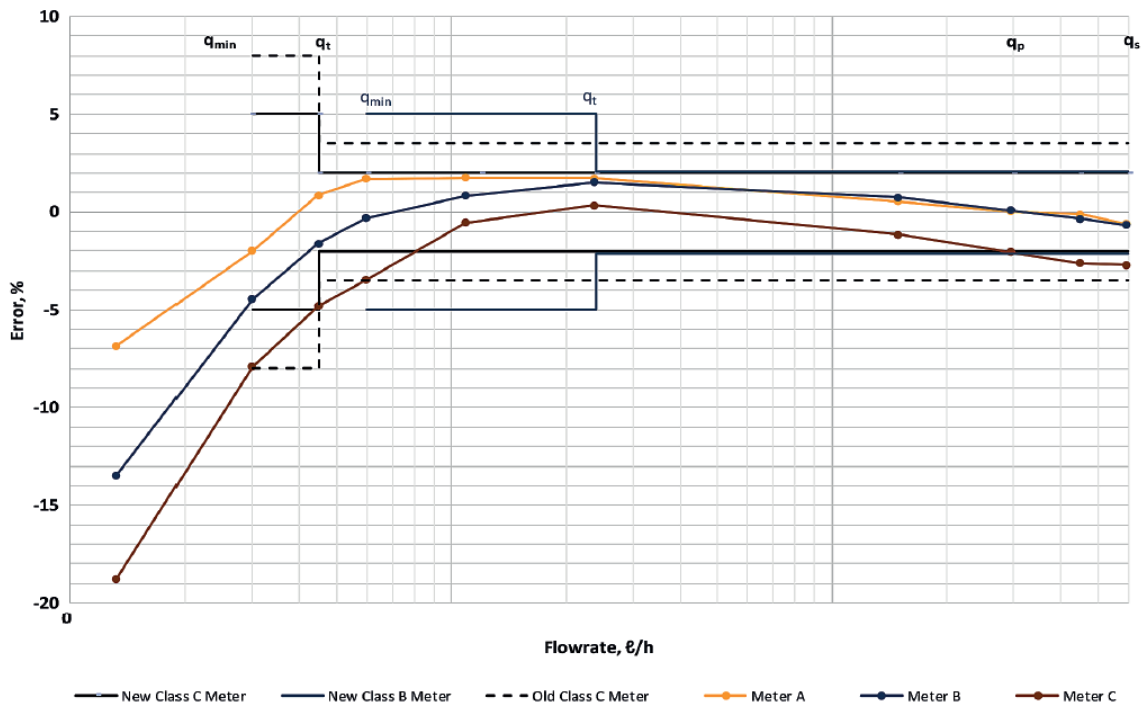

• **Figure 3-16: Typical Error Curves and MPE Envelopes (Ncube & Akpofure, 2019)**

### 3.2.2.1 Issues Affecting Metrological Behaviour of Meters

As any other measuring device, a water meter is not an ideal instrument and is not capable of registering the exact amount of water passing the meter. Every water meter, no matter its type, has considerable measuring limitations. Since water meter inaccuracies are recognised as a critical component of apparent losses, it is important to be capable of quantifying the magnitude of these measuring errors and how to minimise them (Arregui et al., 2006). At this time there is a general lack of information, based on real data, about the real effect of different parameters in the performance of water meters. Hence, technical staff in the water utility has to evaluate or estimate water meter accuracy and analyse the factors that may have any influence on it, without the help of bibliographic reference or external experience. Water meter metrology is not only exclusive to the design and operating principle of the meter of the meter. The installation configurations and operation and maintenance of bulk meters and the accompanying hydraulic elements are some of the factors that can distort the velocity profile and cause alterations to the metrology of the meter (Arregui et al., 2006), (Fontanazza et al., 2013). Therefore, experimental evaluation of the optimal installation configurations and operational and maintenance of these meters is fundamental for keeping accuracies within standard and subsequently proper control and management of water in pressure networks (Palau et al., 2018). The metrology is affected and altered due to the other factors such as:

- Installation issues
- Operation and maintenance issues

### ***Installation issues***

All flow meters are more accurate if the water has a uniform velocity profile around the pipe's centre axis. The velocity profile can be altered by incorrect installation design. Installation in this regard does not mean the actual installation of the meter, it refers more to the detail design of the pipework around the meter as seen in Figure 3-7 and Figure 3-17 (IHE Delft, 2013) provides a few design issues that could negatively influence the velocity profile:

- Upstream fittings have a bad effect on the profile, some fittings have a worse effect than others (e.g. butterfly valve).
- The fittings cause turbulence in the water which causes the meter to either under or over register the flow.
- Turbulent flow can be avoided by keeping a straight pipe before and after the meter (no bends or fittings). All manufacturers state a minimum upstream and downstream straight pipe lengths from the meter.

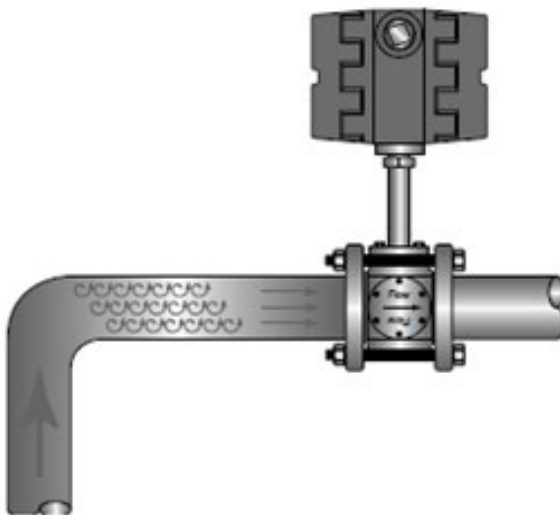

- **Figure 3-17: Turbulence caused by bend or obstruction (IHE Delft, 2013)**

### ***Operational and Maintenance Issues***

Water meters are mechanical devices, which normally deteriorate in performance over time. The fact that a meter does not show outward signs of any damage and has a register that appears to be turning does not mean that the meter is performing in a satisfactory way. It is necessary to conduct preventive care for water meters after proper installation.

In general, if a water meter is out of order due to any physical damage or non-operation of the registration device and is beyond economical repair, it should be replaced with immediate effect (Ministry of Housing and Urban Affairs, 2020). The performance of a meter depends upon:



- The quality of water meter produced by the manufacturer and it differs from manufacturer to manufacturer;
- The design of pipeline & fittings in line with the meter;
- The workmanship & care when handling and installing the meter;
- The pattern of water passing through the meter;
- The type of supply of water whether it is continuous or intermittent;
- The meter maintenance, and testing;
- The proper meter selection; and
- Installation procedure as per standards to be followed

The performance of a water meter is to be monitored continuously with suitable history sheets and in service performance monitoring. Any abnormality noticed needs immediate action. Removing a faulty meter timeously especially mechanical type meters, prevents cascade and cumulative damages.







### 3.2.3 Meter Applications

Water utilities are one of the major users of flowmeters, using the technology every day to ensure that their customers are billed properly based on their actual usage and there is no water that is unaccounted for. These flowmeters are placed at points along the water utility infrastructure where the lines branch out to provide services to residential and business customers (FlowMetrics Inc, 2017). Flowmeters can also be used at other points in the utility system. For example, flowmeters can be used in the larger part of the infrastructure to ensure that the rate of flow is as expected. This helps identify issues in the utility owned lines such as leaks or breaks. They can also be used to monitor the rate of flow from a well or other water sources. This is echoed by van Zyl (2011) who states that it good practice to install water meters at the following points in a distribution system as show in Figure 3-18:

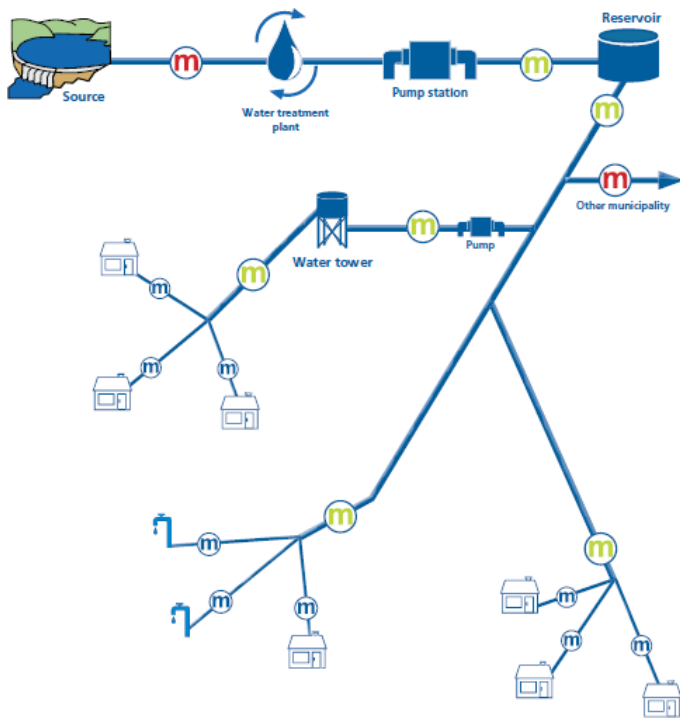
- Raw water withdrawals from dams, boreholes or other sources.
- Clean water production at the outflow of water treatment plants.
- Connection points to bulk water suppliers or other municipalities.
- Points in the system where it is important to know how much water is distributed, such as reservoir outflows, pump stations and off-takes to different areas.
- Supply points to district metered areas (DMAs)
- Consumers.





-  Consumer connection meters
-  Bulk transfer meters
-  Network management meters

• **Figure 3-18: Meter Application Points in a Distribution System (van Zyl, 2011)**

Once it has been determined that a water meter should be installed at a given location, it is necessary to consider the application of the meter. It is always advisable to get a specific application guide from the relevant manufacturer of a specific meter. To assist in a preliminary application guide, typical advantages and disadvantages are listed for Volumetric, Ultrasonic meters, Inferential and Electromagnetic (Table 3-1).

• **Table 3-1: Typical advantages and disadvantages for meter applications**

Meter type	Advantages	Disadvantages
Volumetric	<ul style="list-style-type: none"> <li>• High measuring accuracy</li> <li>• Suitable for measuring media with high viscosity</li> <li>• Operates in both flow directions (forward and reverse)</li> <li>• No flow profile effects, thus no inlet and outlet sections required</li> <li>• No external power supply</li> </ul>	<ul style="list-style-type: none"> <li>• Volume measurement only</li> <li>• For liquids only</li> <li>• High pressure drops</li> <li>• Moving parts, wear</li> <li>• Accuracy decreases for lower viscosities due to gap losses</li> <li>• Sensitive to contamination, filter required</li> <li>• Flow blockage at zero flow through solid impurities</li> <li>• Sensitive to overloading</li> <li>• Monitoring and maintenance</li> </ul>



Meter type	Advantages	Disadvantages
Ultrasonic	<ul style="list-style-type: none"> <li>• Unobstructed flow passage</li> <li>• No moving parts</li> <li>• No additional pressure drops</li> <li>• Favourable choice of materials for chemically aggressive liquids</li> <li>• Linear relationship between flow rate and measured variable</li> <li>• Low maintenance</li> <li>• Operates in both flow directions (forward and reverse)</li> <li>• Transit time meters unaffected by temperature, density and concentration</li> <li>• Later installation in existing pipe possible with individual elements, but onsite calibration required.</li> <li>• Monitoring of remote water lines where power supply is limited or non-existent due to ability to operate on battery power and ease of installation.</li> <li>• Smaller diameter pipes</li> <li>• Great for quick surveys of a pipeline</li> </ul>	<ul style="list-style-type: none"> <li>• Still problematic for liquid and gas measurements</li> <li>• Sound beam must traverse a representative cross section, therefore flow profile dependent. Long inlet and outlet sections required</li> <li>• Errors due to deposits</li> <li>• Transit time meters require clean liquids</li> <li>• Doppler meters only for slight contamination or few gas bubbles</li> <li>• Doppler meters affected by sound velocity changes due to temperature, density and concentration</li> <li>• Unsuitable for heavily contaminated liquids</li> <li>• Gas bubbles cause errors</li> </ul>
Inferential	<ul style="list-style-type: none"> <li>• No external power supply for Rotating vane and Woltman meters</li> <li>• Turbine flowmeters suitable for cryogenic liquids</li> <li>• Turbine flowmeters usable at extreme temperatures and pressures</li> </ul>	<ul style="list-style-type: none"> <li>• Limited choice of materials</li> <li>• Only for low viscosities</li> <li>• Moving parts, wear</li> <li>• Sensitive to contamination</li> <li>• Horizontal Woltman meters are flow profile sensitive</li> <li>• Inlet and outlet sections required (not for rotating vane meters)</li> <li>• Affected by overloading and quick changes at high differential pressure, danger of over speeding</li> <li>• Vibration sensitive</li> </ul>



Meter type	Advantages	Disadvantages
Electromagnetic	<ul style="list-style-type: none"> <li>• Unobstructed flow passage without projecting parts</li> <li>• No moving parts</li> <li>• No additional pressure drop</li> <li>• Essentially flow profile insensitive, only short inlet and outlet sections required</li> <li>• Unaffected by changes in temperature, density, viscosity, concentration and electrical conductivity</li> <li>• Favourable choice of materials for chemically aggressive or abrasive measuring media</li> <li>• Unaffected by contamination and deposits</li> <li>• Especially suitable for hydraulic solids transport</li> <li>• Can be sterilized</li> <li>• Linear relationship between flow rate and measured variable</li> <li>• Operates in both flow directions (forward and reverse)</li> <li>• Measuring range setting can be optimized</li> <li>• Low maintenance, but still easy to maintain</li> </ul>	<ul style="list-style-type: none"> <li>• For liquids only</li> <li>• For low conductivity liquids</li> <li>• Gas inclusions cause errors</li> </ul>

Frenzel (2011) recommends that in conjunction with the advantages, further application criteria be considered in Table 3-2.

• **Table 3-2: Meter Application Criteria**

Type of flow meter	Nominal Diameters (mm)	Mounting Position	Reverse flow measurement	Power Supply Needed
Rotary	6-800	Any	Yes	No
Jet (single and multi)	15-50	Horizontal/ Vertical	Yes	No
Woltman	40-400	Horizontal/ Vertical	Yes	Only for transmitters
Combination	5-600	Horizontal/ Vertical	No	Yes
Electromagnetic	1-300	Any	Yes	Yes
Ultrasonic	10-3000	Any	Yes	Yes



### 3.2.4 Meter Selection

Frenzel (2011) recommends a basic guide to meter selection as shown in Figure 3-19. Van Zyl (2011) adds however that it is not so clear cut and that a municipality should have its own policy on water meter selection based on its experience with different meters in its distribution system. In addition to municipal experience, Buenfil (2005) says it is important to select the appropriate meter such that certain requirements must be satisfied in order for the desired measuring effect to be realized. In selecting a meter consideration is given to the measuring medium, the operating conditions, the local site conditions and the measured value presentation.

These four issues are looked in more detail (Buenfil, 2005; Frenzel, 2011; Ministry of Housing and Urban Affairs, 2020):

- Properties of the Measuring Medium
  - Gas, steam: dry, wet
  - Liquids: gas and solids content, crystallizing component deposits, dust in gas
  - Density
  - Temperature and temperature variations
  - Viscosity
  - Electrical conductivity
  - Chemical aggressiveness, material selection
  - Abrasion danger
  - Impacts of water quality (corrosion, presence of sand or other suspended solids, scaling, dissolved air)
- Operating Conditions:
  - Pipe nominal diameter
  - Design of a channel, slopes, damming
  - Pressure rating
  - Flow rate, smallest, largest value: type of flow changes (step changes)
  - Flow conditions: linear, turbulent flow, velocity distribution, swirl, pulsation
  - Bidirectional flow (forward and reverse)
  - Static pressure, pressure shock, pressure drop permissible
- Local Site Conditions:
  - Ambient temperature
  - Humidity effects, degree of protection
  - Dust entry, degree of protection
  - Vibration
  - Pipeline construction upstream and downstream of the measuring point
  - Explosion protection



- Power supply, cabling
  - Electromagnetic and radio frequency interference
  - Mounting options
  - Delivery transportation risks
  - Effects of soil and environment aggression (temperatures, humidity, snow)
  - Accessibility for inspection or replacement routines
- Measured Value Presentation:
    - Measuring accuracy
    - Frequency of reading
    - Fixed, adjustable, internal, external measuring range
    - Internal, external monitoring capabilities
    - Alarm signalling unit
    - Standardized analogue output. If so, what value?
    - Pulse output for remote totalization
    - Communication, which type?
    - Explosion protection
    - Calibratable

Once some of those factors are considered, Ministry of Housing and Urban Affairs (2020) and van Zyl (2011) suggest the following questions can further assist in making a guide to selecting the right meter:

- What is the purpose of the meter?
- Does the meter comply with the required standards and policies?
- Is the meter rated for the expected flow rates and operating conditions?
- Which is the most economical meter to use?
- Does the maximum flow exceed the meter maximum flow rating?
- Is the nominal flow greater than the meter nominal flow rating?
- Is the minimum flow to be measured within the minimum starting flow of the meter?
- Is the water meter selected according to the flow to be measured and not the due to diameter of pipe?





diameter, it is possible to save some money, sacrificing a little of precision, by installing a proportional meter. This is done by placing a parallel detour or by-pass line with a smaller meter on it. Sometimes it is possible to place “batteries of meters”, this is done by means of parallel pipes with different meter diameters on each one (Buenfil, 2005).

The velocity profiles of the approaching water can cause important measurement errors. Installation and operational configurations of bulk meters can severely influence velocity profiles negatively and subsequently affect meter accuracies (Palau et al., 2018). Careful consideration needs to be placed on such configurations in order to achieve an optimal installation. Some general installation configurations are provided in Table 3-3.

Manufacturers have specific installation instructions for their meters. IHE Delft (2013) and Ministry of Housing and Urban Affairs (2020) offer some additional general advice on meter installation

- Comply with manufacturers recommended minimum upstream and downstream straight pipe lengths from the meter.
- Install the meter in the correct direction of flow.
- Avoid fitting insertion and ultrasonic clamp-on meters on the top of the pipe where trapped air can distort the reading.
- Ensure the pipe is always full of water.
- Ensure the water meter shall be handled with great care. Rough handling is likely to damage the meter and affect its accuracy.
- Ensure the water meter shall be installed at a spot where it is readily accessible.
- To avoid damages and overrun of the meter due to intermittent water supply system, it is advisable to install the meter such that the meter always contains water when there is no supply in the line.
- House the water meter in a chamber with the lid for protection.
- Install the meter such that the longitudinal axis is horizontal and the flow of water should be in the direction shown by the arrow cast on the body.
- Before connecting the water meter to the water pipe, the pipe should be thoroughly cleaned by installing a pipe of suitable length and diameter where the meter should be and letting the passage of water flow through preventing the formation of air pockets.
- The meter is installed in the pipeline using flanged or threaded connections giving due consideration for conditioning sections. It should be seen that stress-free installation is carried out in the pipeline.
- It is essential to install the flowmeter such that there is no protruding packing or gasket into the water flow stream.
- Flow meters should be provided with battery backup in order to retain integrator reading during the failure of electric supply.



- **Table 3-3: General Installation Configurations (Ministry of Housing and Urban Affairs, 2020)**

Type	Orientation	Direction	Quoted range of upstream lengths	Quoted range of minimum downstream
Turbine	H, VU,VD,I	U,B	5D/20D	3D/10D
Insertion turbine	H, VU,VD,I	U,B	10D/80D	5D/10D
Electromagnetic	H, VU,VD,I	U,B	0D/10D	0D/5D
Insertion magnetic	H, VU,VD,I	U,B	25D	5D
Doppler	H, VU,VD,I	U,B	10D	5D
Transit time	H, VU,VD,I	U,B	0D/50D	2D/5D

Legends: H: Horizontal flow; U: Unidirectional flow; VU: Upward vertical flow; B: Bidirectional flow; VD: Downward vertical flow; D: Inner diameter of pipe; I: Inclined flow

### 3.3 Meter Calibration

In cities when consumers must pay their water bills according to the volumes used, meters must be massively installed, so the logistics to assure their timely reading, quality, precision, repair, replacement and several other aspects, require thorough technical assessment and planning (Buenfil, 2005). Various types of flow meters have mobile parts subject to wear, alteration, clogging with debris or scaling, so it is necessary to make periodic tests or replacements to assure their accuracy and proper performance. They could also have manufacturing defects or disarrangement during transport. IHE Delft (2013) recommends that meter sampling surveys be undertaken to help get to the root of what is causing poor meter performance issues. These surveys can be organised to find out issues with water meters caused by:

- Meter size
- Meter age
- Meter maintenance
- Meter installation

Calibration helps to correct some meter performance issues. New and recently acquired meters usually are randomly tested at the utility's laboratory, on a testing bench, against the accepted standard. According to Ministry of Housing and Urban Affairs (2020) flow meter calibration is essential to:

- Confirm performance of flowmeter
- Quality control





- Comply with statutory or legal requirements
- Provide traceability of measurement and confidence in resultant data.

### 3.3.1 Legislation

The main laws that have a bearing on water metering in South Africa are the Municipal Services Act and the Trade Metrology Act. The South African Trade Metrology Act requires water meters of sizes 15 to 800 mm to comply with the requirements of SANS 1529 and that municipalities must ensure that all meters under their control are kept in a verifiable condition at all times. This means that a municipal meter shall have to be verified before installation and at intervals specified by the Act in section 52 of the Act. The verification has to be done by a qualified and registered Verification Officer in a SANAS Accredited Test Laboratory in terms of SANS 103784.

Water meters larger than 100 mm cannot easily be tested in South Africa and many other countries since large enough testing facilities are not available. However, it is still required that the meter undergoes certain tests at the SABS, and that the suppliers provide a verified accuracy curve for the meter.

### 3.3.2 Standards

International water meter standards tend to be very similar on major issues such as meter accuracy and classification barring American standards (van Zyl, 2011). The South African Bureau of Standards (SABS), the national institution responsible for regulating the quality of South African goods and services, sets technical specifications for water meters and metering systems, i.e. the South African National Standards (SANS1529) to maintain the quality and requirements for water meters used in South Africa (Malunga, 2017; Ngabirano, 2017).

It is easy to determine whether locally manufactured meters are SANS compliant as they have a SABS mark on them. However, determining SANS compliance for products that are manufactured abroad and newly evolving is quite a challenge as they comply with the standards of the country of origin in the first instance. Some of the important basic parameters to check compliance with SANS are outlined in the following subsections as per SANS 1529:

- Materials
- Operational Conditions
- Metrology
  - It is also a requirement that meters be designed such that they can withstand accidental reverse flow and indicate it (Van Zyl, 2011). The maximum permissible error (MPE) of a meter is also outlined in the standards and can be positive or negative. This maximum permissible error envelope is divided into two zones namely the lower and upper



zones, and SANS 1529 specifies a minimum permissible relative error of 5% in the lower zone, and 2% in the upper zone. This must be ensured after every installation. However, meters in the field are capable of errors of up to 1.5 times those of the new ones.

- Indication of the meter reading

### 3.3.3 Testing

There are two philosophies of flow meter calibration. One is that it is better to have a fixed calibration system with all the associated technical back up and with the flow meters being brought to the calibration system, the other favours calibrating in situ leaving the flow meters in their installed condition and using a portable calibrator. The former will generally provide the more accurate calibration but the latter has the advantage that site-specific effects such as proximity to hydraulic disturbances can be taken into account. It is necessary to decide carefully to adopt the option (Ministry of Housing and Urban Affairs, 2020). No testing laboratories in South Africa can test meters larger than 100 mm, and thus field testing is often the only method available for large meters (Van Zyl, 2011).

Any method used to test the accuracy of a meter should be substantially more accurate than the meter being tested. Meters that are tested for other purposes, for instance as part of a replacement study, can be tested to the municipality's own standards. However, the accuracy of these tests is still very important. All large meters need to be tested at regular intervals. The American Water Works Association (AWWA) recommends that meters between 25 and 100 mm are tested every five years, and meters of 100 mm and larger every year. Older meters and meters with the highest readings should be tested first as they are most likely to have deteriorated.

#### 3.3.3.1 Lab methods

Various methods are available for testing the accuracy of water meters. The most precise method is to remove the meter from the field and test it on a laboratory test bench. However, while such measurements are highly accurate and repeatable, they are not able to replicate site conditions that might affect the meter (Van Zyl, 2011). The calibration is normally carried in the flow laboratory with the help of one of the following methods (Ministry of Housing and Urban Affairs, 2020).

#### ***Gravimetric***

A flow meter can be calibrated gravimetrically by weighing the quantity of liquid collected in a vessel. The vessel is weighed empty, then full and the difference calculated. This gives the weight of the fluid collected (Frenzel, 2011).



## ***Volumetric***

The measurement of the quantity of liquid collected may be carried out volumetrically by collecting a known volume of liquid in a container. In the volumetric method the standard vessel takes the form of a container with a calibrated volume. Normally this will be a vessel with conical ends to facilitate drainage and to reduce the risk of air entrapment. The neck of the vessel is normally fitted with a sight glass and a scale marked in volumetric units. A typical volumetric tank is shown below. Various shapes of vessel are used. Inclined cylindrical vessels with the necks at opposite ends are one design, as are simple 'cans' with no bottom drain and the level being established at the top 'brim'. This latter type is used for the calibration of fuel dispensers (Frenzel, 2011).

## ***Prover***

Pipe provers provide probably the best calibration devices for truly dynamic calibration. They are used in a sealed system and provide high accuracy. Provers, can be used in-situ as travelling standards, be part of a metering system or be used as the reference in calibration laboratories.

The pipe prover principle is illustrated diagrammatically. A length of pipe is fitted with switches and the volume between the switches is known. If a displacer is introduced to the flow, the time it takes to travel between the switches will give a measure of the flowrate (UNIDO, 2019).

The four main classifications of liquid pipe provers are:

- Uni-directional sphere prover
- Bi-directional sphere prover
- Piston provers
- Small volume provers

## ***Master or reference meter***

A master meter is a calibrated flowmeter that is used as a calibration standard. The master meter is to be calibrated through a process that can be traced back to some national or international standard (Yoder, 2015). The master meter is placed in series with the flowmeter under test, and the results are compared at different flowrates.

If the limits of the error for the meter being tested exceed the acceptable error as specified in the standard, then the regulator is readjusted on the meter being tested if it is available in the meter.



### 3.3.3.2 In-Situ Methods

In-situ verification is actually the final step in a process for verifying the accuracy of measuring meters. It is also potentially a very expensive procedure to carry out and so the accuracy of every meter is not likely to be checked every year. How often meters are verified in situ, and the methods used, will be determined by individual jurisdictions. (Cape et al., 2008).

The major constraint with the in-situ method is that the high accuracy laboratory calibration cannot be matched in the field and accuracies of  $\pm 2\%$  to  $\pm 5\%$  is all that can be achieved and such field tests are called confidence checks rather than absolute calibrations. Such checks are often the precursor to the removal of flow meter for laboratory calibration or replacement (Ministry of Housing and Urban Affairs, 2020).

In Situ verification can be carried out using the methods (Cape et al., 2008), (UNIDO, 2019):

- Master or reference Meter
- Tracer Methods
- On-Site Volumetric or Gravimetric Methods

#### ***Master or reference meter***

A reference meter is brought to site and fitted to the service meter installation pipe work. The reference can also be located somewhere in the pipe system where hydraulic conditions are favourable. It is important to ensure no losses or leaks can occur between the service and reference meter. This technique requires a number of conditions to be met to achieve a good level of accuracy.

#### ***Tracer Methods***

A pulse of tracer fluid is injected into the main flow stream and the time taken for the tracer to pass between two detection points is measured. The fluid flow rate is a function of the tracer injection rate and its downstream concentration. Tracers should be stable, should not deposit or react with chemicals in the water or with the pipe walls.

#### ***On-site Volumetric or Gravimetric Method***

The measurement of the quantity of liquid collected may be carried out volumetrically by collecting a known volume of liquid in a container. Smaller flowmeters could be calibrated in this way using a container, however for larger flowmeters this could be impractical. There however lies an opportunity in utilizing the reservoir storage as the known volume with which the meter can be calibrated.



### 3.4 Reservoirs

Water is considered as the source living for every creation as it is a crucial element for healthy living. Safe drinking water is one of the basic elements for human to sustain a healthy life. High demand for safe and clean water is rising day by day as one cannot live without water. Thus, it becomes necessary to store water, water is stored generally in reservoirs and later on it is distributed to different areas where it is required. Reservoir is a common term applied to a liquid storage structure and it can be below or above the ground level. Reservoirs below the ground level are normally built to store large quantities of water whereas those of overhead type are built for direct distribution by gravity flow and are usually of smaller capacity (Alfanda & Farouk, 2017).

#### 3.4.1 Types of typical reservoirs

According to the material, storage tanks can be divided into metal tank and non-metallic tank. Types of storage tanks can be divided in accordance with the position, shape, and structure of storage tank.

- According to the position: above ground storage tank, underground storage tank, elevated storage tank.
- According to the fluid type: potable water, raw water, crude oil storage tank, diesel tank, fuel oil tank, fire water tank, etc.
- According to the application: industrial or commercial storage tank.
- According to the shape: vertical storage tank, horizontal storage tank.
- According to the structure: fixed roof tank, floating roof tank, spherical tank.
- According to the material: concrete, brick, steel, plastic, other.
- According to the capacity: tank with capacity more than 100m<sup>3</sup> are large storage tanks, most of which are vertical storage tanks; the others are small storage tank, mostly are horizontal storage tank.

Some typical storage tanks and their internal support structures are shown in Table 3-4.

- **Table 3-4: Typical storage reservoirs and internal support structures**

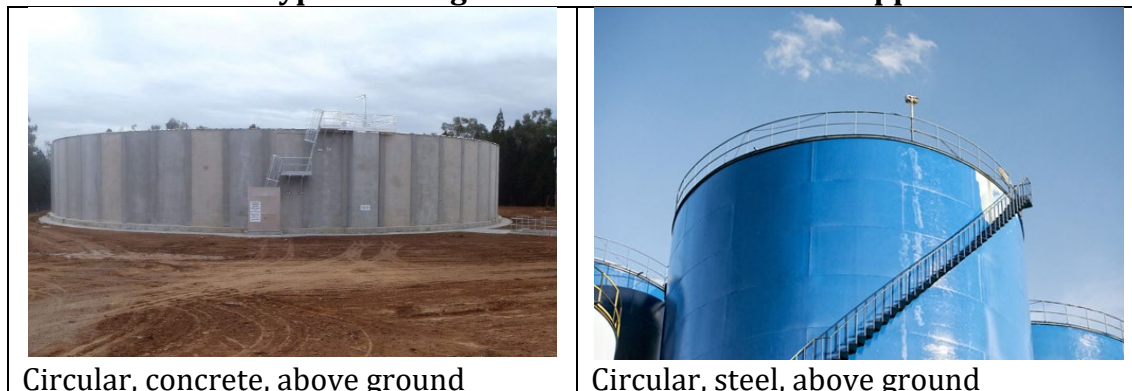



Circular, concrete, elevate storage



Circular, steel, elevated storage



Rectangular, concrete, above/below ground



Rectangular, steel, above ground

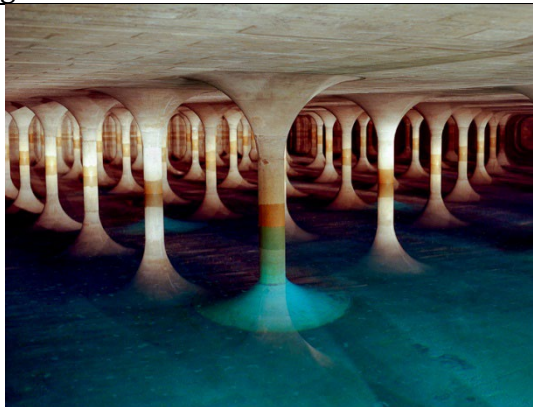

Internal support columns



Dividing walls and columns



Internal support columns, concrete reservoir



Internal supports, steel reservoir tank

### 3.4.2 Reservoir Water Level Measurement

Whenever water parameters are considered, both water quantity and water quality must be given equal weightage. Instrumentation facilitates the coordination of various water



parameters, which are essential for the optimization of water supply and treatment plants. One of the important parameters amongst them is water level measurement at reservoirs (Ministry of Housing and Urban Affairs, 2020).

Reservoir level measurement is accomplished through two Direct or Inferential methods ways as shown in Table 3-5 and Table 3-6 respectively.

• **Table 3-5: Direct Reservoir Level Measurement Methods**

<b>Hook Type Level Indicator</b>	<b>Sight Glass</b>	<b>Float Type Indicator</b>
<b>Advantages</b>		
<ul style="list-style-type: none"> <li>i. Low cost</li> <li>ii. Simple</li> </ul>	<ul style="list-style-type: none"> <li>i. Inexpensive</li> <li>ii. Corrosion resistive</li> <li>iii. Simple</li> </ul>	<ul style="list-style-type: none"> <li>i. The level can be read at a convenient place</li> <li>ii. Operates over large temperature range</li> <li>iii. Very accurate</li> </ul>
<b>Disadvantages</b>		
<ul style="list-style-type: none"> <li>i. Only local reading</li> <li>ii. Human error may be encountered in reading</li> </ul>	<ul style="list-style-type: none"> <li>i. Only local reading</li> <li>ii. Accuracy and readability depends on the cleanliness of glass and fluid</li> <li>iii. It is fragile</li> </ul>	<ul style="list-style-type: none"> <li>i. They are tailored to tank geometry</li> <li>ii. Requires a certain amount of mechanical equipment</li> </ul>
<b>Uses</b>		
<ul style="list-style-type: none"> <li>i. Inlet channel level</li> </ul>	<ul style="list-style-type: none"> <li>i. Filter bed level</li> <li>ii. Reservoir level</li> <li>iii. Head loss in the filter</li> </ul>	<ul style="list-style-type: none"> <li>i. Filter bed</li> <li>ii. Final water reservoir</li> <li>iii. Sump well</li> <li>iv. Lime tank</li> </ul>



• **Table 3-6: Inferential Reservoir Level Measurement Methods**

<b>Hydrostatic Pressure Gauge Type &amp; Pressure Bulb Type</b>	<b>Displacer Level Type</b>	<b>Electrical Method (Capacitance Type)</b>	<b>Ultrasonic</b>
<b>Advantages</b>			
<ul style="list-style-type: none"> <li>i. Easy maintenance</li> <li>ii. Simple to adjust</li> <li>iii. With pressure, bulb type remote reading possible</li> <li>iv. Reasonably accurate</li> </ul>	<ul style="list-style-type: none"> <li>i. Excellent accuracy</li> <li>ii. Possible at remote places</li> </ul>	<ul style="list-style-type: none"> <li>i. Good accuracy</li> <li>ii. Possible at remote places</li> <li>iii. Very sensitive</li> <li>iv. Suitable for highly corrosive media</li> </ul>	<ul style="list-style-type: none"> <li>i. Good accuracy</li> <li>ii. Possible at remote places</li> <li>iii. Suitable for liquid as well as bulk products</li> </ul>
<b>Disadvantages</b>			
<ul style="list-style-type: none"> <li>i. The instrument must be installed at base reference level for gauge type</li> <li>ii. Pressure bulb type relatively costly</li> </ul>	<ul style="list-style-type: none"> <li>i. Limited range</li> <li>ii. High cost</li> <li>iii. Requires stilling chamber</li> <li>iv. Requires a significant amount of mechanical equipment</li> </ul>	<ul style="list-style-type: none"> <li>i. Affected by dirt &amp; other contaminants</li> <li>ii. Affected by temperature</li> </ul>	<ul style="list-style-type: none"> <li>i. Affected by foam</li> <li>ii. Not suitable for high temperature &amp; pressure</li> </ul>
<b>Uses</b>			
<ul style="list-style-type: none"> <li>i. Delivery head of the pump (pressure gauge type) Clear or raw water reservoir</li> <li>ii. Sump level</li> </ul>	<ul style="list-style-type: none"> <li>i. Clear water reservoir</li> <li>ii. Raw water reservoir</li> </ul>	<ul style="list-style-type: none"> <li>i. Raw water reservoir</li> <li>ii. Clear water reservoir</li> </ul>	<ul style="list-style-type: none"> <li>i. Raw water as well as clear water level i.e. inlet channel sump level etc.</li> <li>ii. Lime tank</li> <li>iii. Sludge level</li> </ul>





## 4. METHODOLOGY

### 4.1 Measuring equipment

#### 4.1.1 Flow meters

Investigations on the suitable meters to use as verification meters for the sites were undertaken. The investigations focused on the metrology requirements and accuracies that are better than the in-service meters.

#### 4.1.2 Reservoir level meters

Investigations on the suitable pressure measuring devices to use as verification for the current level measurement readings at reservoirs were undertaken. The investigations focused on the metrology requirements and accuracies that are better than the in-service level meters. Since the reservoir is to be used as a possible new verification method, further investigations will be conducted on the types of pressure/level measuring devices that can meet the metrological requirements along with practical considerations to testing.

### 4.2 Methodology





**A Water Meter Calibration Using Reservoir Volumetric Characteristics (WMCURVC)** procedure with the necessary technology is being proposed.

The **WMCURVC** procedure has the following steps (depicted in Table 4-1):

1. Define the volumetric characteristics of the storage reservoir (as built drawings, physical measurements, 3D scanning).
2. Install the pressure transducers, water level sensors, loggers at the reservoir (inlet and outlets).
3. Follow the developed step-by-step procedure to close and open the supply inlets and outlets to allow for dedicated flow through a flow meter and enable the recording of the change in volumetric volume in the reservoir at a frequency of 1Hz for a specified period of time.
4. Repeat the steps for different flow conditions (range).
5. Repeat these steps for the different flow meters that need to be calibrated.
6. Analyse the data and compare the Reservoir Volumetric determined flow rate with that of the installed flow meter reading.
7. Some of the measuring components will remain in the reservoir to assist with long term monitoring and water balancing.

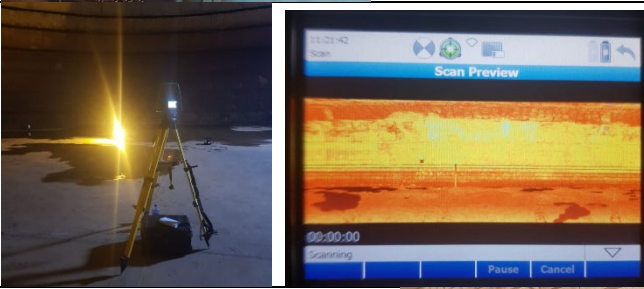
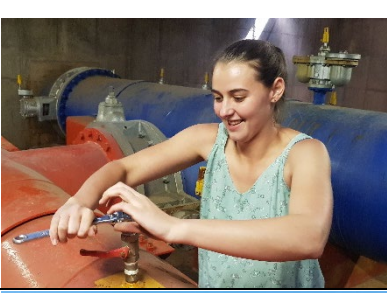

- **Table 4-1: Diagram of the proposed Water Meter Calibration Using Reservoir Volumetric Characteristics process flow**

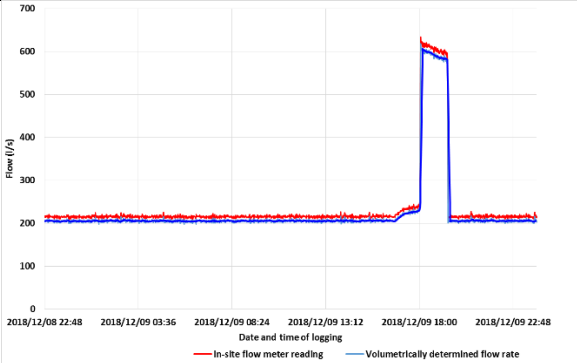
	Description	Picture
Phase 1: Site selection	Identify site and evaluate installed flow meters. Obtain range and status quo.	
	3D scanning of reservoir or utilize as-built drawings or physical measurements	
Phase 2: Field measurements	Install pressure transducers, level sensors and loggers on supply line and reservoir outlets	 
	Install sensors inside reservoir.	 
Phase 3: Data analyses	Analyse the data and compare the reservoir volumetric determined flow rate with that of the installed in-situ flow meter reading. Calculate the economic impact of the difference in readings	



## 5. TEST SETUP AND LAYOUT

A simplified proposed test setup is as shown in Figure 5-1.

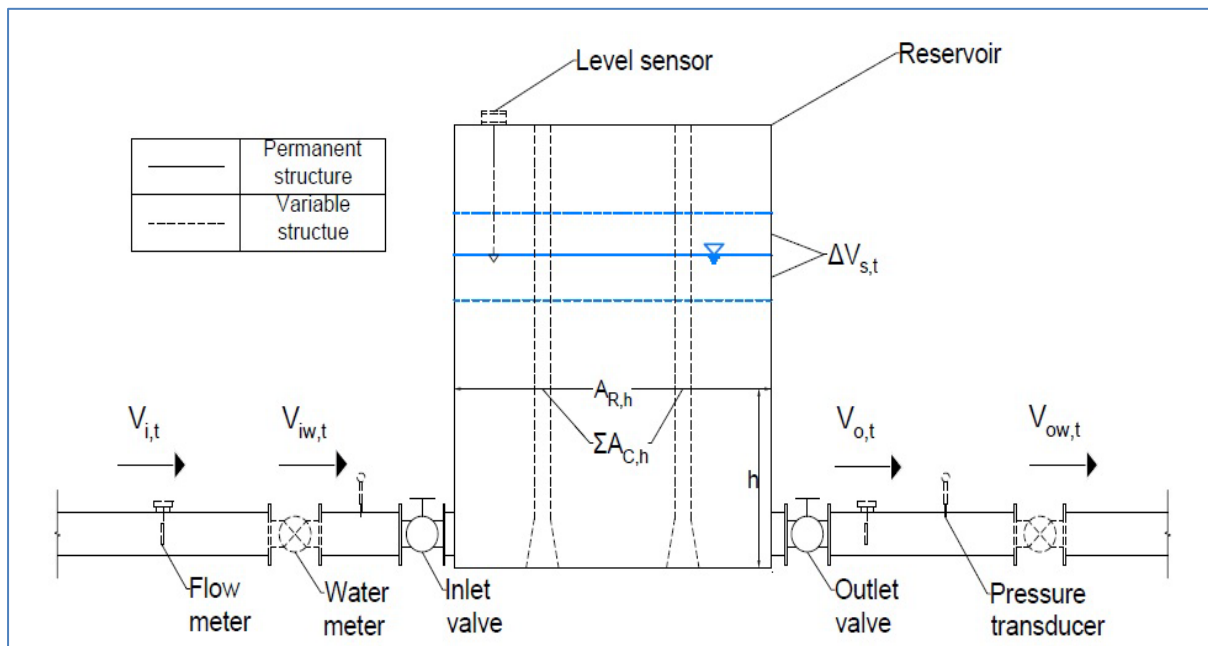

• **Figure 5-1: Test setup**

Figure 5-1 illustrates the test procedural layout including the measuring equipment that will be installed. The measuring equipment include flow meters; pressure transducers and a level sensor, of which the type will still be determined. The following components are represented as variable:

- Water meters: The location and functionality may vary for each reservoir site.
- Measuring equipment: Installation location and type of equipment used may vary.
- Reservoir columns: Size and amount of columns vary for each reservoir structure

The components that will be measured are as illustrated in Figure 5-1 and discussed in Table 5-1.

• **Table 5-1: Measured components**

<b>Component</b>	<b>Discussion</b>
$V_{i,t}$	Inflow volume after time t
$V_{iw,t}$	Inflow volume given by inlet water meter after time t
$V_{o,t}$	Outflow volume after time t
$V_{ow,t}$	Outflow volume given by outlet water meter after time t
$\Delta V_{s,t}$	Change in reservoir storage volume due to inflow (closed outlet); outflow (closed inlet); or leakage (closed in- and-outlet) after time t
$A_{R,h}$	Reservoir cross sectional area at height h where: $h=n.\Delta h$ $n$ =incremental steps $\Delta h$ =fixed incremental height
$\Sigma A_{C,h}$	Sum of cross-sectional areas of all columns at height h

The testing procedure can be divided into 3 phases and a number of steps in each phase.

Phase 1: Site selection

Phase 2: Field measurements

Phase 3: Data analyses

This is described in more detail in the following paragraphs.

## 5.1 SITE SELECTION CRITERIA

The proposed testing procedure requires a reservoir site that would allow for a simple yet adequate application of the procedure. Figure 5-2 looks at the site selection process with the proposed criteria discussed in Table 5-2.



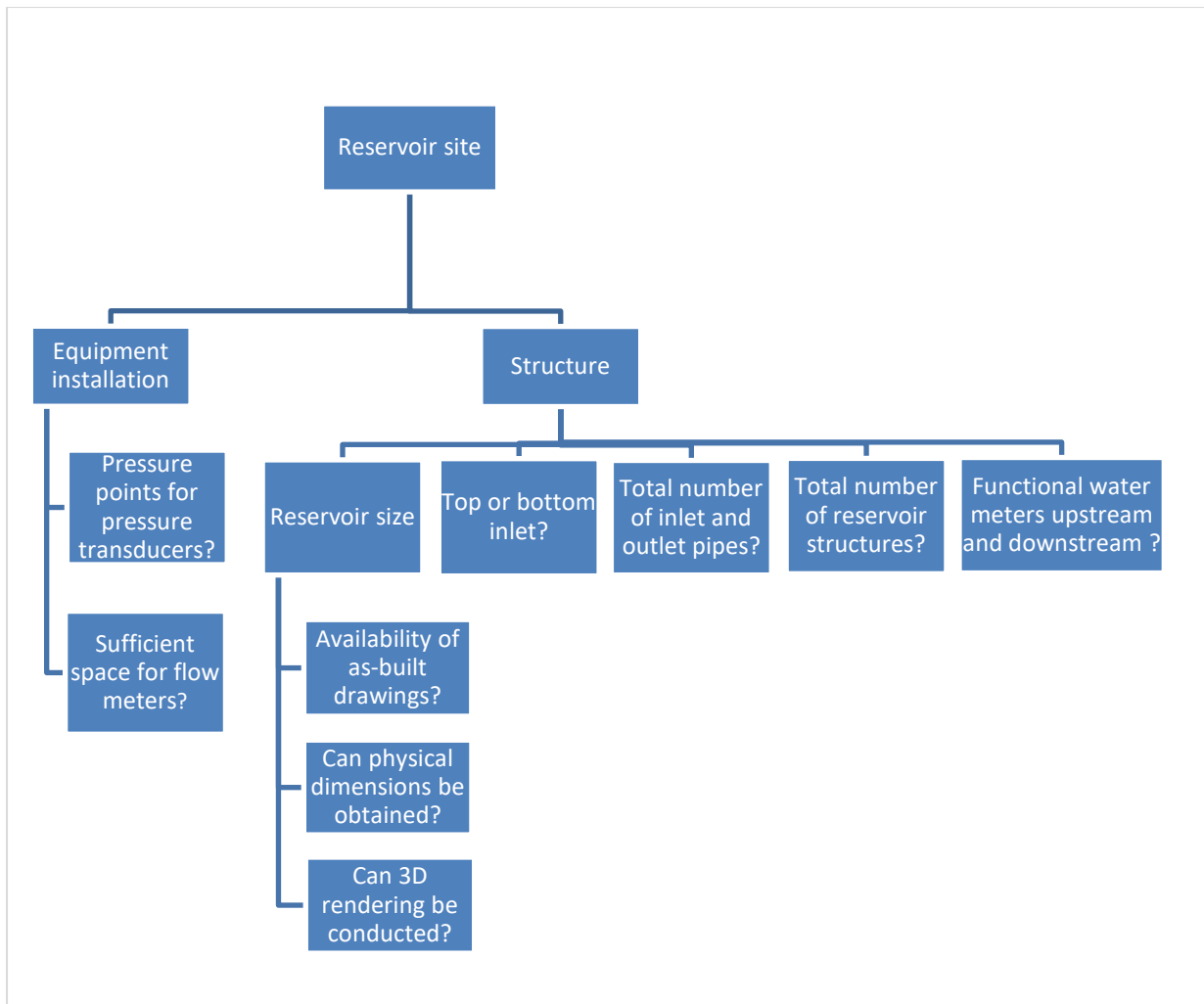

• **Figure 5-2: Site selection process**

• **Table 5-2: Site selection criteria**

Component	Criteria
<b>Structure</b>	
Water meters	Functional water meters on both the inlet and outlet side
Inlet and outlet pipes	Single pipe at the inlet and outlet of the reservoir structure
Reservoir structures	Single reservoir structure
Reservoir size	Determinable by at least two modes (physical, 3D or as-built). Verification on the reservoir dimensions can therefore be conducted.
Inlet type	Bottom or top inlet. Consideration with regards to measuring is discussed in Table 5-3
<b>Equipment installation</b>	
Installation of flow meters	Sufficient space should be available for the installation of flow meters on the upstream side of the water meters.
Installation of pressure transducers	Pressure points on the inlet and outlet should be available for the installation of pressure transducers.



A few aspects that should be considered in conducting the test procedure is discussed in Table 5-3.

- **Table 5-3: Test procedure considerations**

<b>Component</b>	<b>Consideration</b>
<b>Reservoir inlet</b>	
Water level	Consideration should be given as to the reservoir operating level upon testing as turbulence on the water surface (for a low water level) may have an impact on the results obtained from the level sensor(s)
Operating flow range	The current operating flow range should be established as this will determine whether the water meter(s) are accurate and if not, to what extent
Equipment resolution	Equipment resolution that will be able to match the accuracy required
Reservoir columns	The amount and size will have an impact on the volume of water at a specific water level.
Variation in water level during test procedure	It may be necessary to limit the duration of testing as significant changes in reservoir volume can affect the consumers on the downstream side.



## 5.2 TESTING PROCEDURE

The step-by-step test procedure is discussed in Figure 5-3 with the primary steps that include establishment of the reservoir volumetric characteristics; installation of measuring equipment; validation of inlet and outlet water meters; and leakage determination.

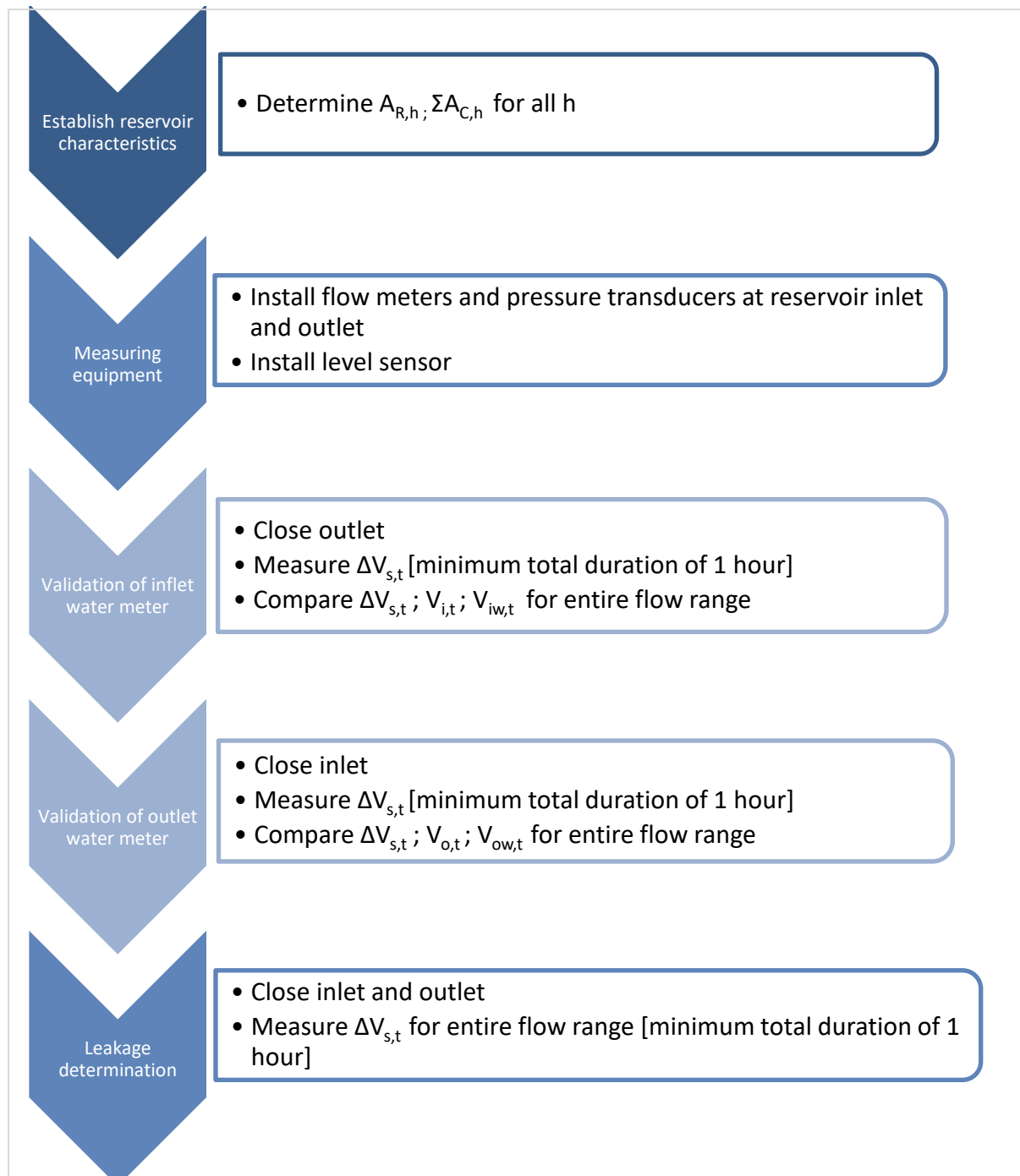

• **Figure 5-3: Test procedure**



## 6. IMPLEMENTATION

### 6.1 PHASE 1: SITE SELECTION

The project is done in collaboration with the City of Tshwane. The City of Tshwane (now including Metsweding) receives Bulk water from Rand Water, Magalies Water and own sources including Boreholes, Water Purifications Plants and Fountains. Water is then distributed as shown Figure 6-1, in through a large water system that includes 160 reservoirs, 42 water towers and 10 677 km of pipes.

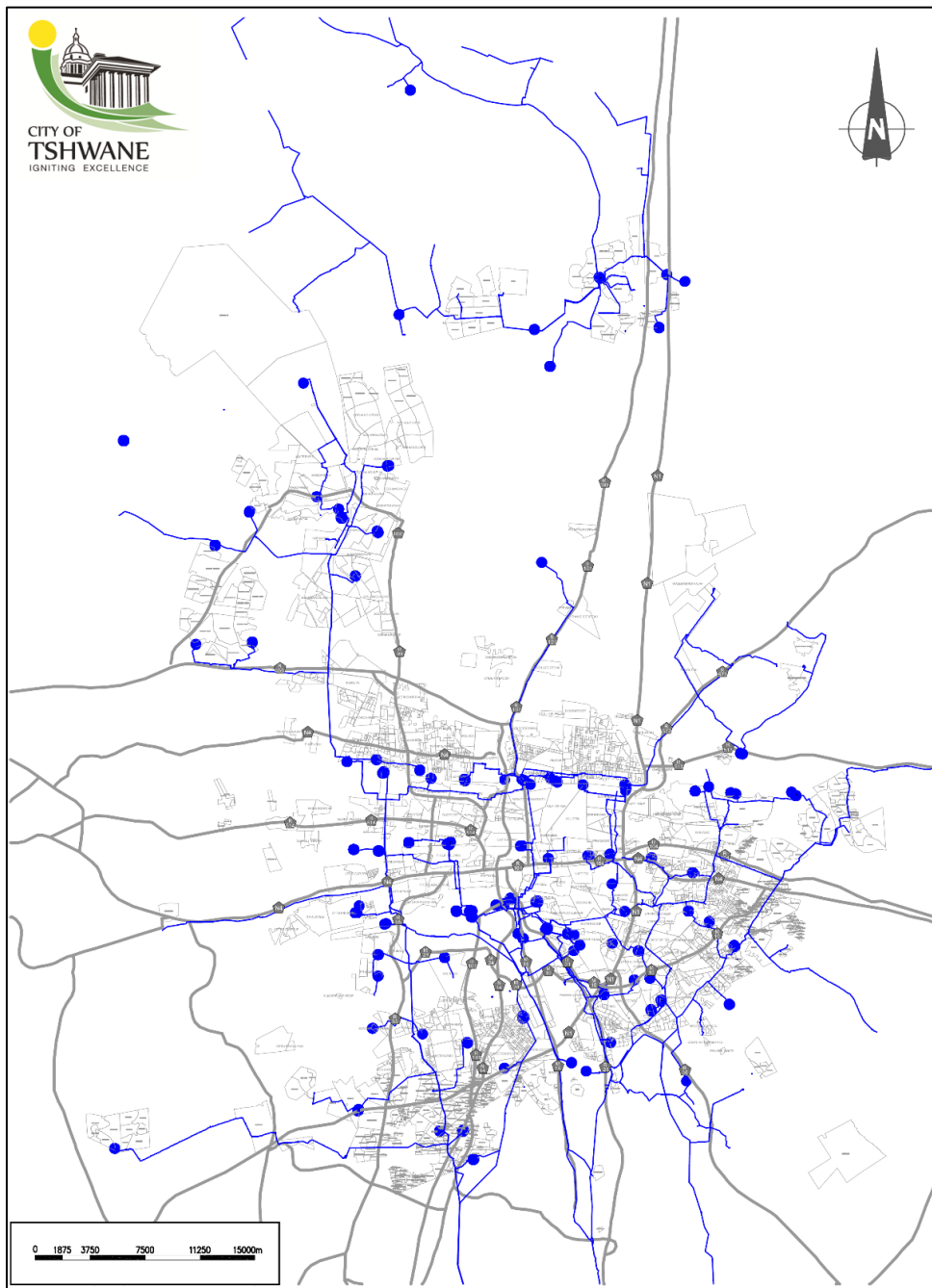

• **Figure 6-1: Reservoirs and bulk pipelines in Tshwane WDS**



The Pierre van Ryneveld Reservoir is located south of Pretoria as shown in Figure 6-2.



- **Figure 6-2: Location of Pierre van Ryneveld Reservoir**

The site was selected as it located inside the secure Country Lane Estate and it consists of two reservoirs (old 7.6 ML and new 15 ML).

The two reservoirs are currently operational, supplying water to the Pierre van Ryneveld suburb, near Centurion. The old reservoir is a medium sized, round and built from post-tensioned reinforced concrete with a concrete slab roof. The old reservoir has a diameter of 32 m and a height of 10 m with a total capacity of 7.6 ML. The source of the water is from Rand Water, bulk pipeline.

The new reservoir constructed in 2011 was constructed, to meet growing demand due to new developments in the area. The new reservoir has a capacity of 15 ML receiving its water from the same source.

The Pierre van Ryneveld reservoir has all the components of a typical water reticulation storage reservoir. There is an inlet pipe, outlet pipe, various control valves, flow meters, strainers and telemetry as shown in Figure 6-3.



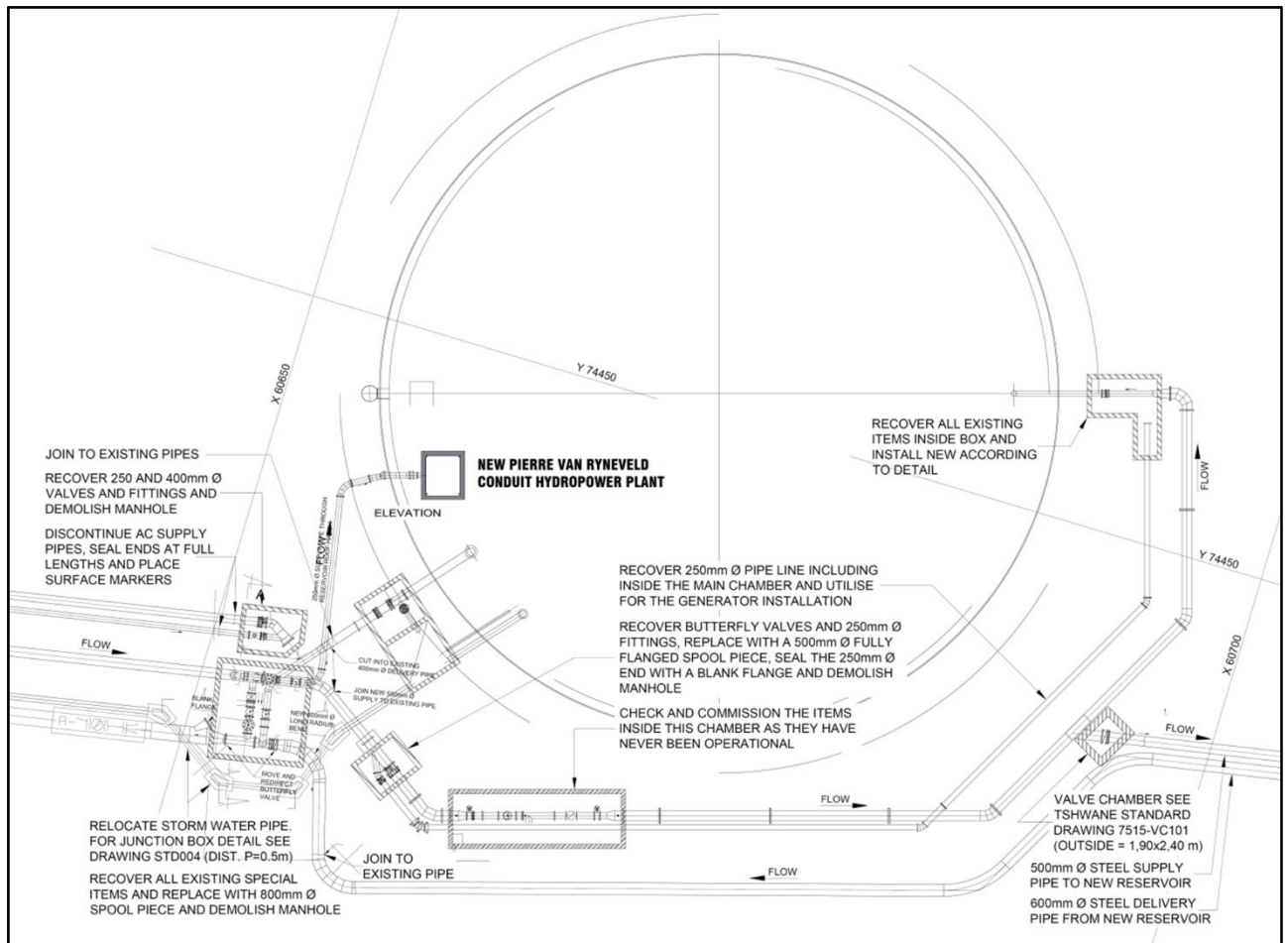

- **Figure 6-3: Layout of pipe system at old reservoir**

Water flows into the reservoir via an inlet pipe. As indicated in Figure 6-3 water flow into the reservoir is governed by control valves. PRV's, flow control valves (FCV) and level control valves are vital in operating the system.

The current set-up of the pipe network system at the old Pierre van Ryneveld reservoir is shown in Figure 6-4. This image is taken from the Infrastructure Management Query Structure (IMQS) software used by Tshwane Municipality to manage its infrastructure. The pipe represented in blue is the bulk pipe connecting the reservoir inlet to the Rand Water pipeline near the booster pump-house. This pump-house is positioned directly alongside the R21 road. Water flows from the Rand Water pipeline connection along this pipe into the Pierre van Ryneveld reservoir. Figure 6-5 and Figure 6-6 shows the new reservoir construction.





- **Figure 6-4: Plan view of bulk water pipe connecting reservoir to Rand Water (IMQS, 2011)**
- 



- **Figure 6-5: Construction of new reservoir**





- **Figure 6-6: In and outlet pipes (bottom of reservoir)**

As indicate in Figure 5-2 the site selection process with the proposed criteria discussed in Table 5-2 was performed to determine if this would be a suitable site.



- **Table 6-1: Application of site selection criteria – Pierre van Ryneveld reservoir complex**

<b>Component</b>	<b>Criteria</b>	<b>Status</b>
<b>Structure</b>		
Water meters	Functional water meters on both the inlet and outlet side	Yes
Inlet and outlet pipes	Single pipe at the inlet and outlet of the reservoir structure	Yes
Reservoir structures	Single reservoir structure	There are two reservoirs which provides flexibility to still be able to supply the area during the testing phase
Reservoir size	Determinable by at least two modes (physical, 3D or as-built).	As-built and 3D
Inlet type	Bottom or top inlet.	Bottom inlet
<b>Equipment installation</b>		
Installation of flow meters	Sufficient space should be available for the installation of flow meters on the upstream side of the water meters.	Yes
Installation of pressure transducers	Pressure points on the inlet and outlet should be available for the installation of pressure transducers.	Yes

## 6.2 PHASE 2: FIELD MEASUREMENTS

The Pierre van Ryneveld reservoir complex has all the components of a typical water reticulation storage reservoir. There are inlet pipes, outlet pipes, various control valves, flow meters, strainers, and telemetry.

### 6.2.1 Site layout

Figure 6-7 shows the site layout of the Pierre van Ryneveld complex. Also indicated are the locations of the various test chambers (A-E) and the system flow regime structure.

Figure 6-8 illustrates and discusses detail on the various components for each chamber. The components that are of importance include isolating valves, pressure reducing valves and in-service flow meters (also illustrated in Table A-1).



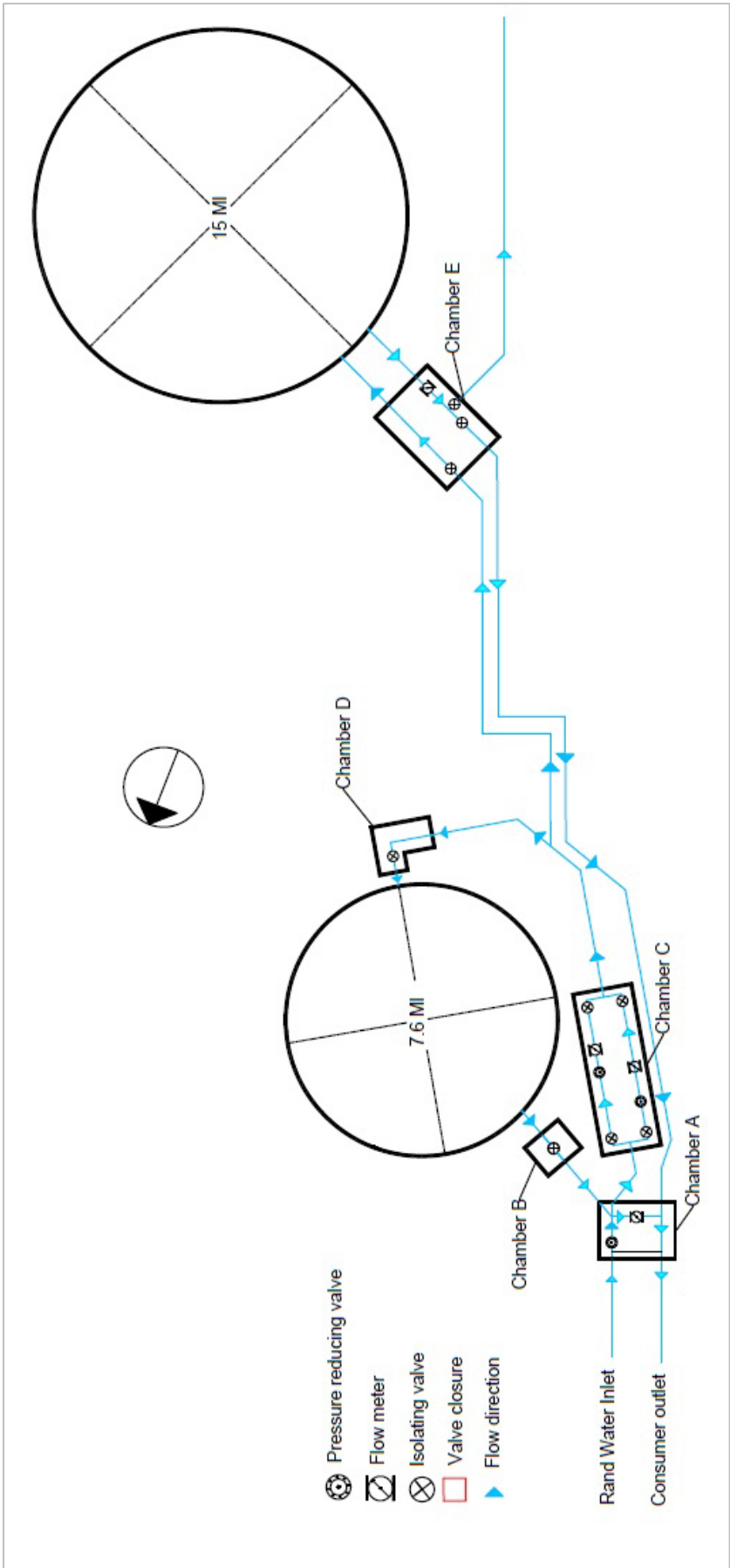

• **Figure 6-7: Site layout – Pierre van Ryneveld complex**



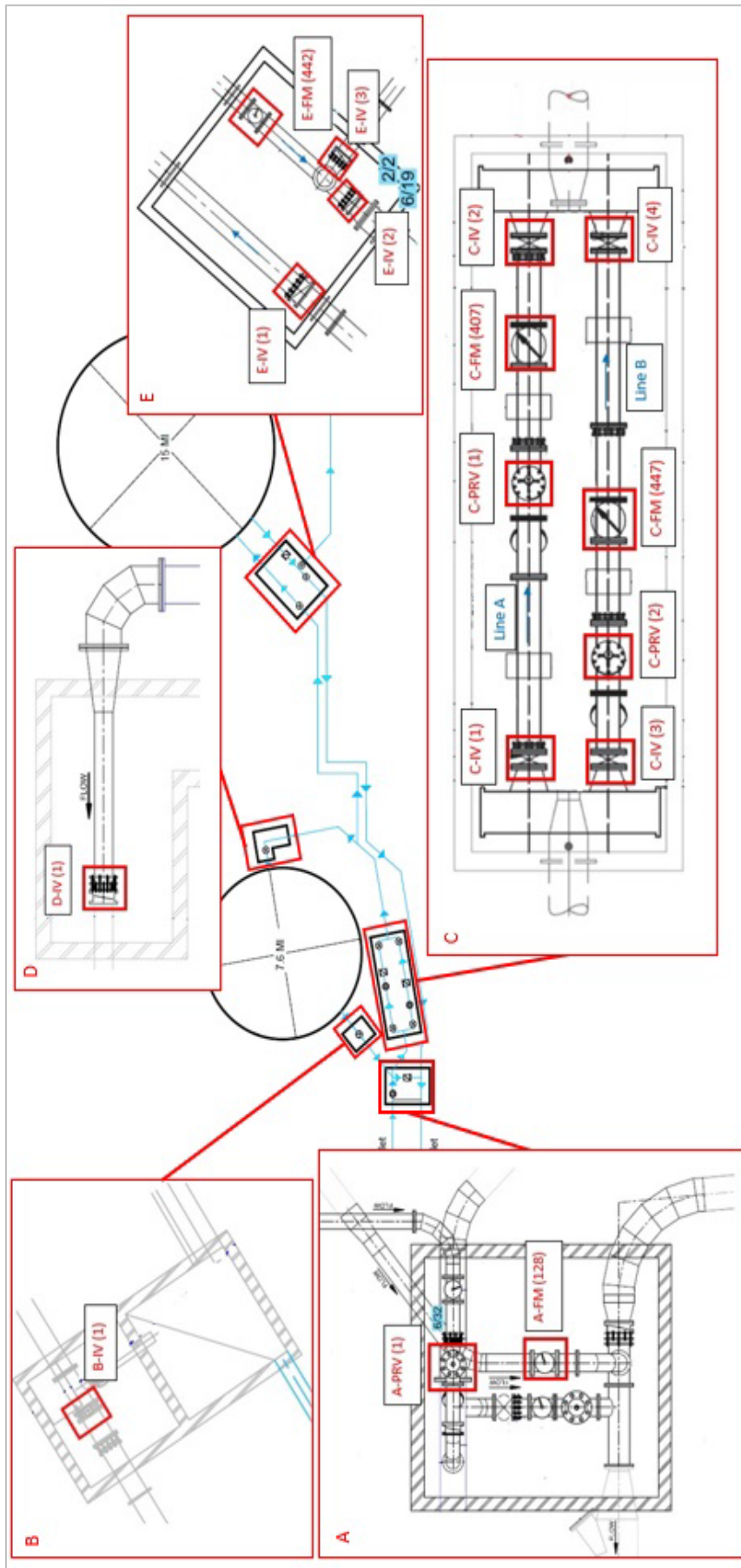

• **Figure 6-8: Chamber detail – Pierre van Ryneveld**



## 6.2.2 Chamber components

The annotated chamber components illustrated in Figure 6-8 was described according to the process discussed in Figure 6-9.

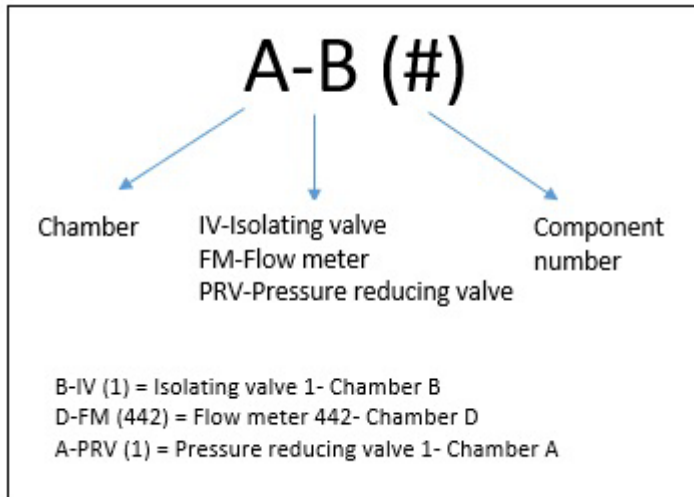

• **Figure 6-9: Component description**

Detailed description on the various chamber components is discussed in Table 6-2

• **Table 6-2: Chamber detail**

Chamber	Components	Discussion
A	<ul style="list-style-type: none"> <li>A-PRV (1)</li> <li>A-FM (128)</li> </ul>	<ul style="list-style-type: none"> <li>Rand Water pipeline entry.</li> <li>Outlet flow meter for 7.6 Ml reservoir.</li> <li>Outflow to reticulation network (outflow from 7.6 Ml and 15 Ml reservoir).</li> </ul>
B	<ul style="list-style-type: none"> <li>B-IV (1)</li> </ul>	<ul style="list-style-type: none"> <li>7.6 Ml reservoir outlet isolating valve</li> </ul>
C	<ul style="list-style-type: none"> <li>C-IV (1); C-IV (2); C-IV (3); C-IV (4);</li> <li>C-FM (407); C-FM (447)</li> <li>C-PRV (1); C-PRV (2)</li> </ul>	<ul style="list-style-type: none"> <li>Two PRV lines (level control).</li> <li>Two flow meters operating as inlet meters for both reservoirs.</li> <li>C-FM (447) is not operational.</li> <li>Verification for meter on line A only. Meter serves as inflow meter for both reservoirs.</li> </ul>
D	<ul style="list-style-type: none"> <li>D-IV (1)</li> </ul>	<ul style="list-style-type: none"> <li>7.6 Ml reservoir inlet isolating valve</li> </ul>
E	<ul style="list-style-type: none"> <li>E-IV (1); E-IV (2); E-IV (3);</li> <li>E-FM (442)</li> </ul>	<ul style="list-style-type: none"> <li>In and outlet isolating valves for 15 Ml reservoir.</li> <li>Flow meter operating as outlet meter for 15 Ml reservoir.</li> </ul>

## 6.2.3 Test procedure

The test procedure that includes opening and closing of the various isolating valves are discussed in Table 6-3.





• **Table 6-3: Test procedure**

Action	Reservoir			
	7.6 MI		15 MI	
	Measure (min. 1hr)	Verification meter	Measure (min. 1hr)	Verification meter
Start: All valves open				
Step 1: Close D-IV (1) Close C-IV (3); C-IV (4)	$\Delta V_{s,t}$  <u>Compare with:</u>  $V_{o,t}$ (UFM) $V_{o,t}$ (FM)	A-FM (128) (outlet)		
Step 2: Close B-IV (1)	$\Delta V_{s,t}$			
Step 3: Open D-IV (1) Close E-IV (1)	$\Delta V_{s,t}$  <u>Compare with:</u>  $V_{i,t}$ (UFM) $V_{i,t}$ (FM)	C-FM (407) (inlet)		
Step 4: Open B-IV (1) Close E-IV (2), E-IV (3)			$\Delta V_{s,t}$	
Step 5: Open E-IV (1) Close D-IV (1)			$\Delta V_{s,t}$  <u>Compare with:</u> $V_{i,t}$ (UFM) $V_{i,t}$ (FM)	C-FM (407) (inlet)
Step 6: Open D-IV (1) Close E-IV (1) Open E-IV (2), E-IV (3)			$\Delta V_{s,t}$  <u>Compare with:</u> $V_{o,t}$ (UFM) $V_{o,t}$ (FM)	E-FM (442) (outlet)
End: All valves open [Open E-IV (1); C-IV (3); C-IV (4)]				

The procedure discussed in Table 6-3 allows for tests to be conducted at both reservoirs whilst still be able to always provide water to the reticulation network. Each flow meter is verified separately with leakage determination conducted in conjunction with the verification process.

The steps discussed in Table 6-3 are further illustrated in Figure 6-10 to Figure 6-13.



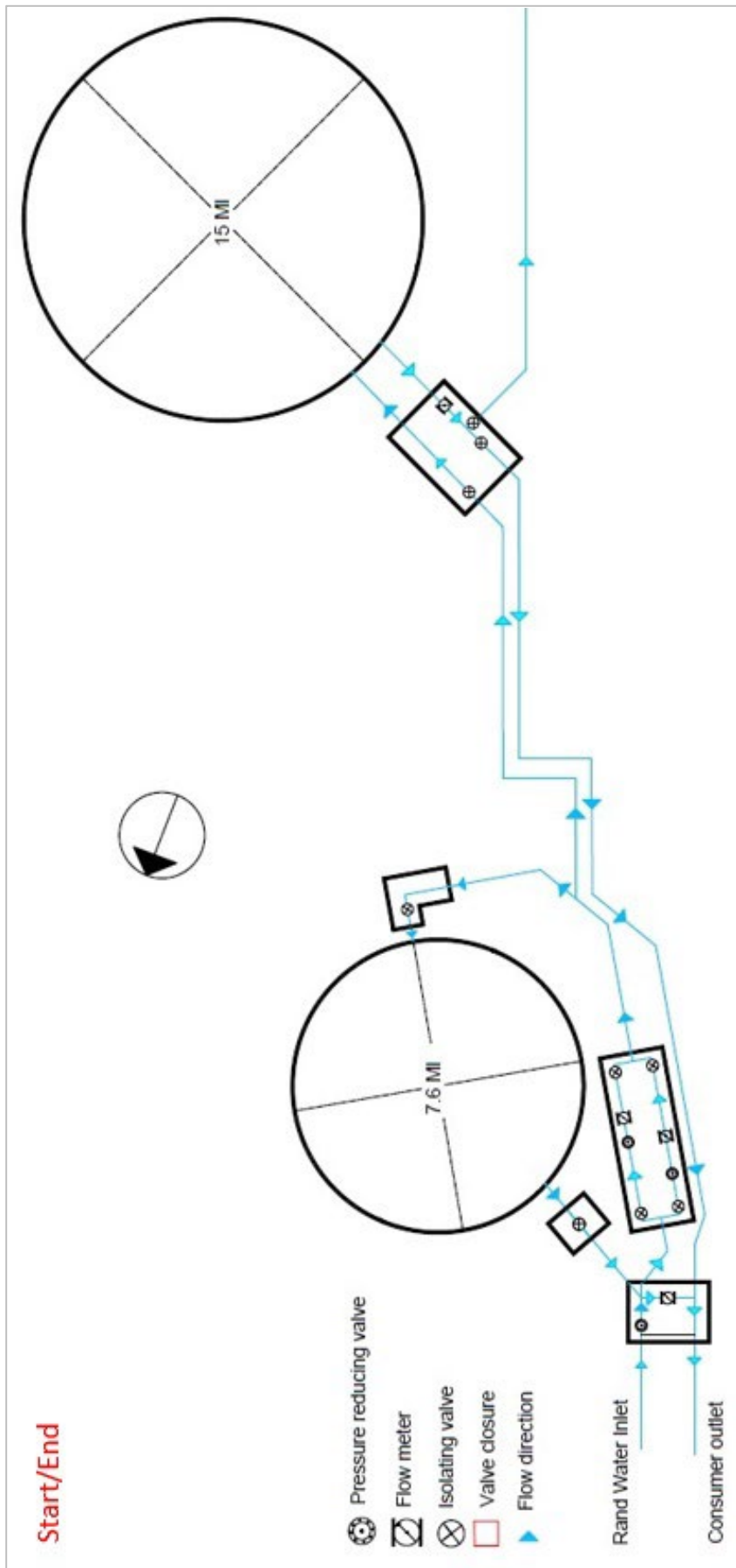

- **Figure 6-10: Testing procedure – Start/End (all valves open)**



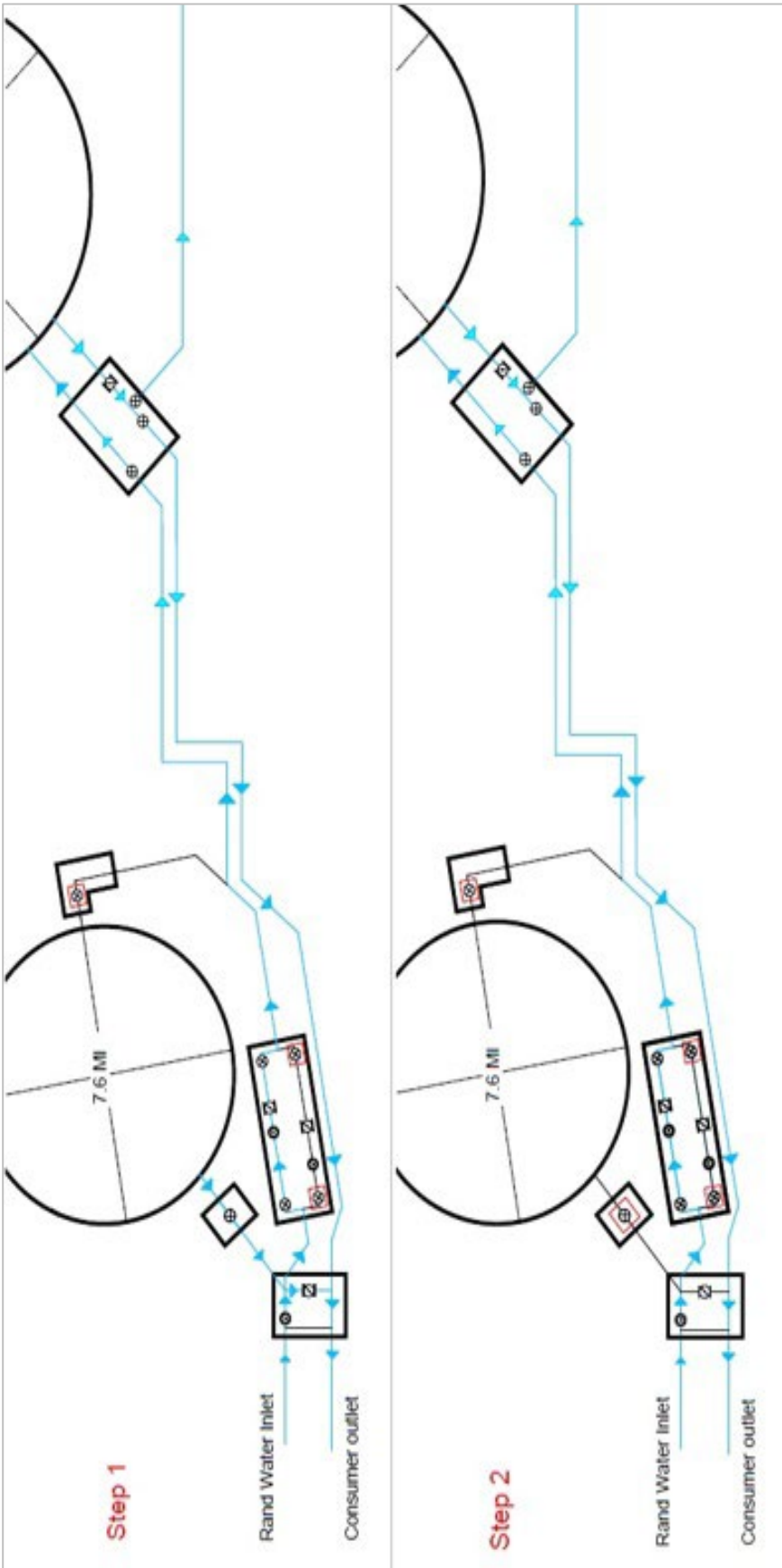

**Figure 6-11: Testing procedure – Steps 1 and 2**



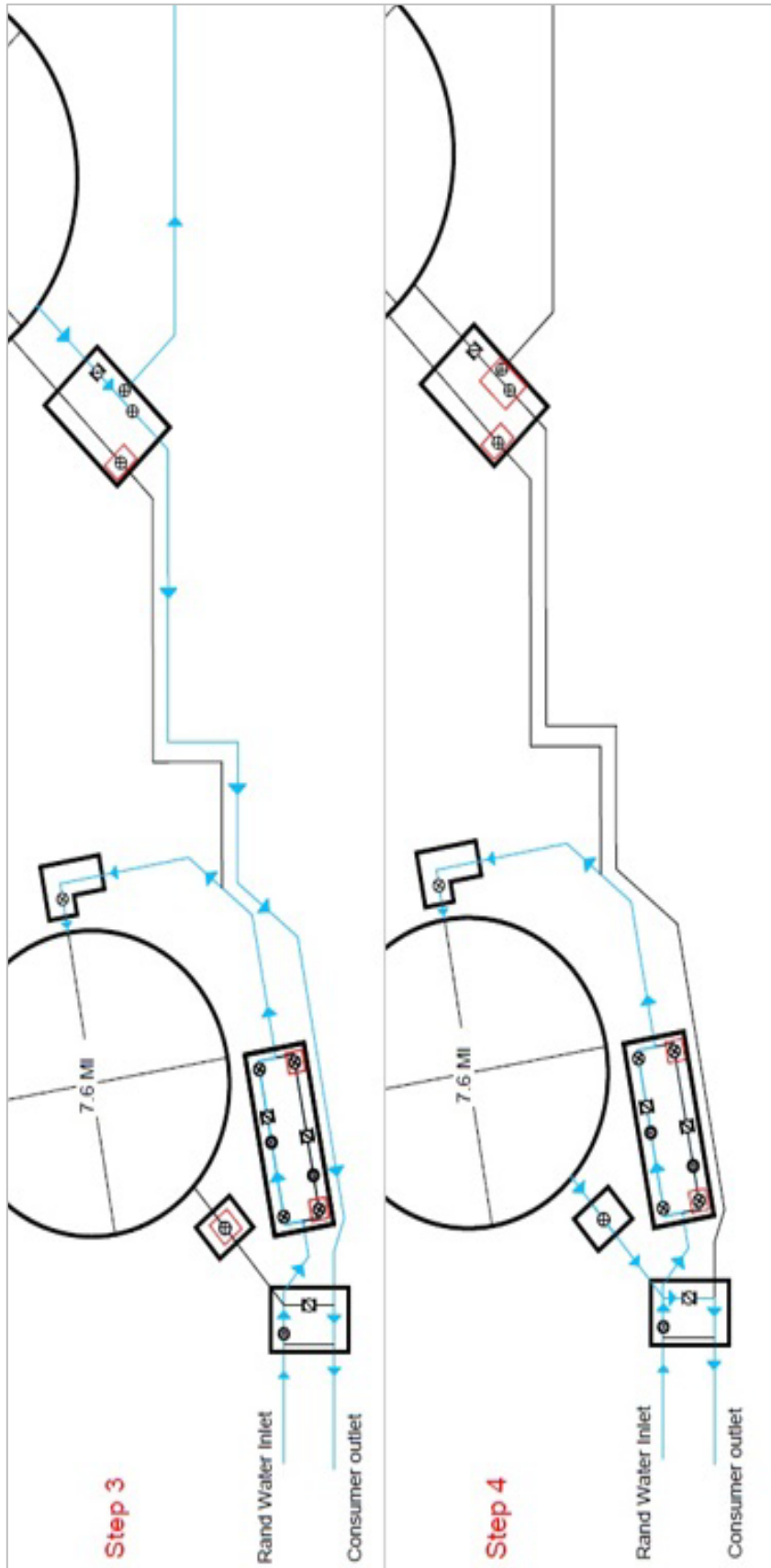

**Figure 6-12: Testing procedure - Steps 3 and 4**



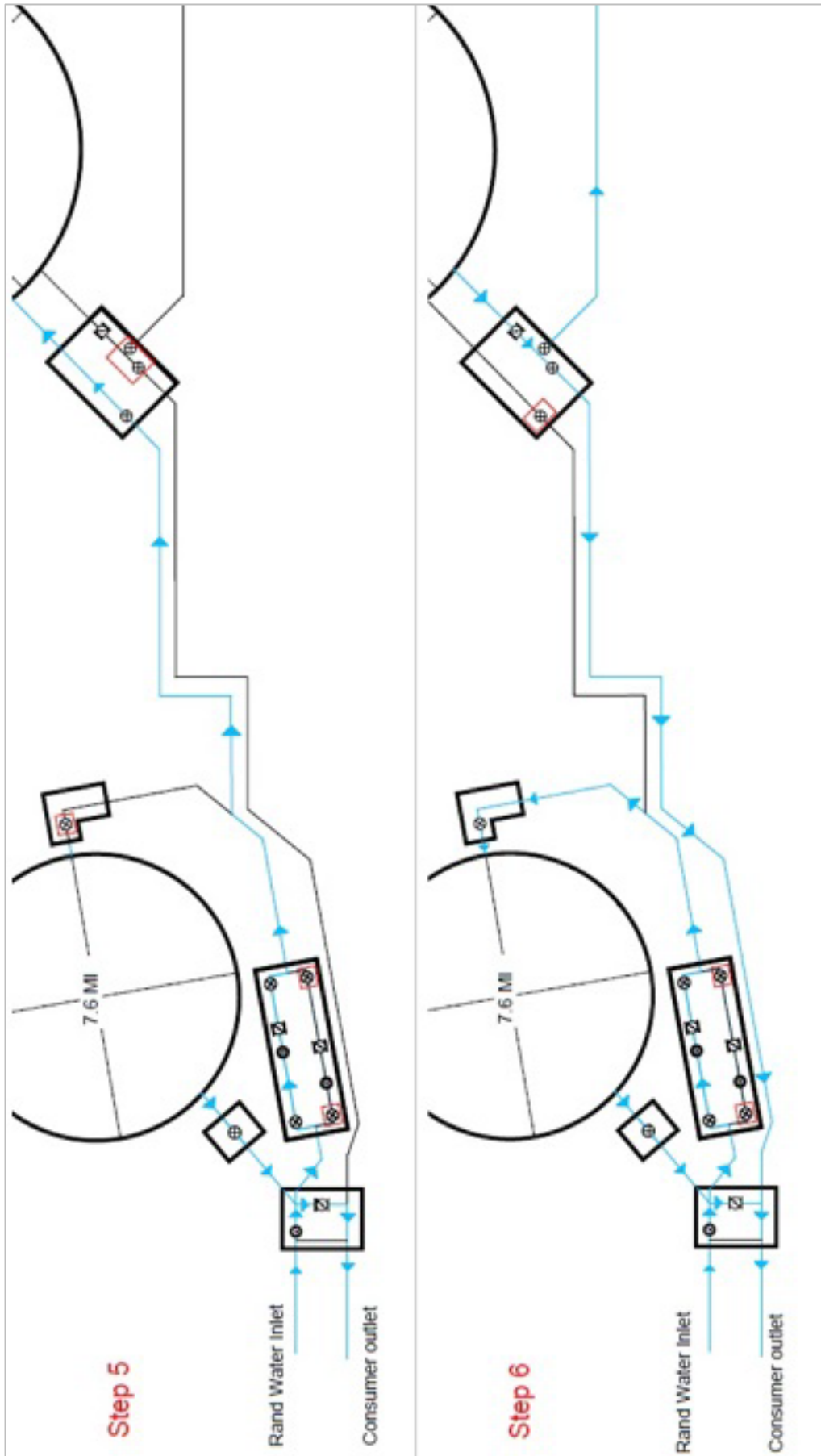

• **Figure 6-13: Testing procedure - Steps 5 and 6**



## 6.2.4 Testing

During the testing the water level in the reservoir was measured using two loggers and the flow was measured using an ultrasonic flow meter comparing this with the in-situ flow meter values.

### 6.2.4.1 HOBO U30 GSM logger with battery charger

A HOBO U30 GSM logger (Figure 6-21) was used. The system transmits data to the web via cellular communications for easy access from internet-enabled devices, however in this installation it was downloaded to a computer.

The battery chargers are rated for 240 V and 50 Hz input power and an input adapter were also acquired for each logger. The 12 bit, 4-20mA, adapters can be set to a switched input that extends the life of external batteries. It also provides a trigger signal for controlling power to attached external sensors, while offering digital filtering which improves measurement accuracy with 32 readings/sample and 60 Hz noise rejection.



(a) HOBO U30 GSM logger



(b) Battery charger



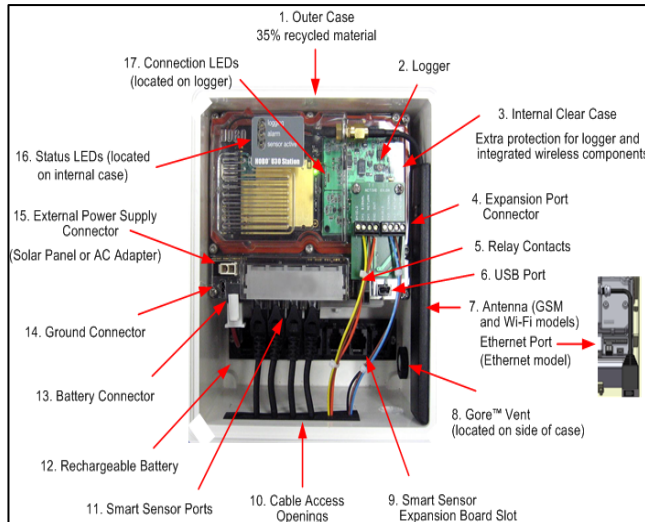

(c) U30 logger components



(d) Installed U30 logger

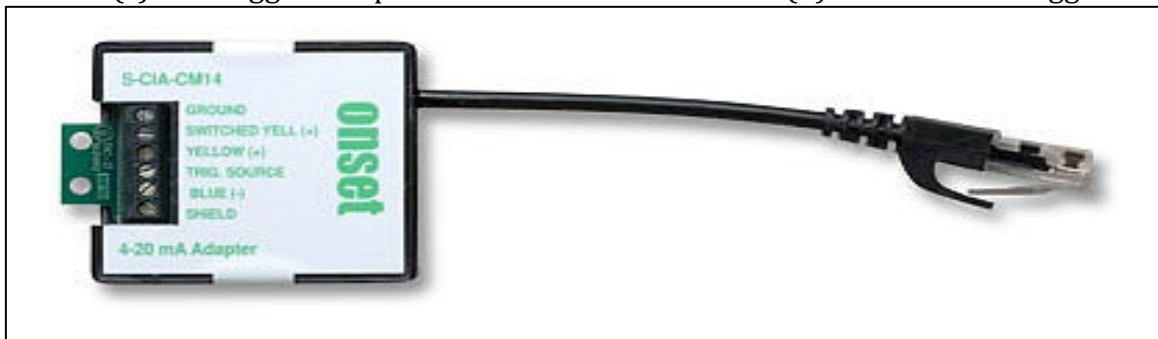

(e) 12 bit adapter

- **Figure 6-14: HOBO U30 GSM logger with battery charger**

#### 6.2.4.2 HOBO Water Level Logger 9 m

A HOBO Water Level Logger was used with the data downloaded using an optic base station and HOBOWare Pro software (Figure 6-22).

The HOBO Water Level data loggers can be installed in freshwater canals, streams, rivers or lakes and can measure water levels with high accuracy, with no cumbersome vent tubes or desiccants to maintain.

The Optic USB Base Station and couplers will be used to offload data from the water level loggers. The Base Station connects to a computer via USB, while connecting to the logger via an appropriate coupler.

The 12 bit, 4-20mA, adapters can be set to a switched input that extends the life of external batteries. It also provides a trigger signal for controlling power to attached external sensors, while offering digital filtering which improves measurement accuracy with 32 readings/sample and 60 Hz noise rejection.

The HOBOWare Pro software can be used to Plot or export data to spreadsheets to conduct analysis necessary for your project. HOBOWare® Pro is easy to set up and its intuitive, point-and-click interface makes it simple to run. This data logging application is compatible with all HOBO data loggers and wireless data nodes.



(a) HOBO 9 m water level logger



(b) Optic base station

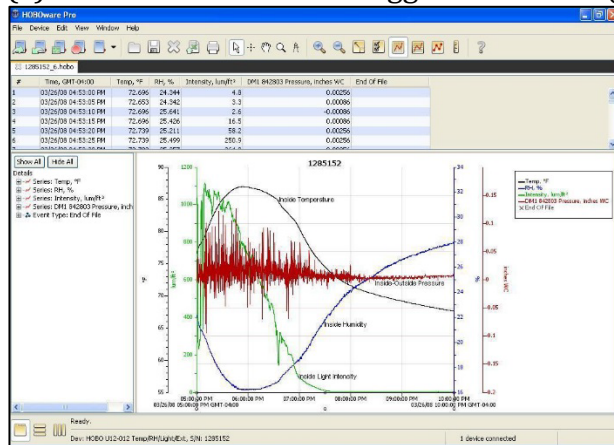

(c) HOBOWare Pro software

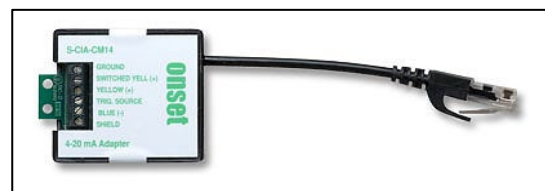

(d) 12 bit input adapter

- **Figure 6-15: HOBO U20 Water Level Logger 9 m**





### 6.2.4.3 Pressure measurement

Pressure was also measured using Gems pressure transducers, Figure 6-23, (ranging from 1 – 2 bar) capable of measuring the expected variance in pressure at the specific location.



- **Figure 6-16: Pressure transducers**

### 6.2.4.4 Flow meter (master meter)

An ultrasonic flow meter was purchased and utilised at the testing site. Data at a frequency of 5 Hz is recorded and stored on the portable flow meter and transmitted via serial cable to a computer.

The flow meter is a Flowmetrix ultrasonic flow meter (Model: SAFSONIC P PORTABLE ULTRASONIC FLOWMETER), Figure 6-24. It utilizes Middle sensor type (Model: M2) which can be installed on pipes ranging from 50 – 700 mm in diameter. It has a frequency range of 1 Hz.





- **Figure 6-17: Ultrasonic flow meter**



- **Figure 6-18: Inlet flow meter - C-FM (407)**



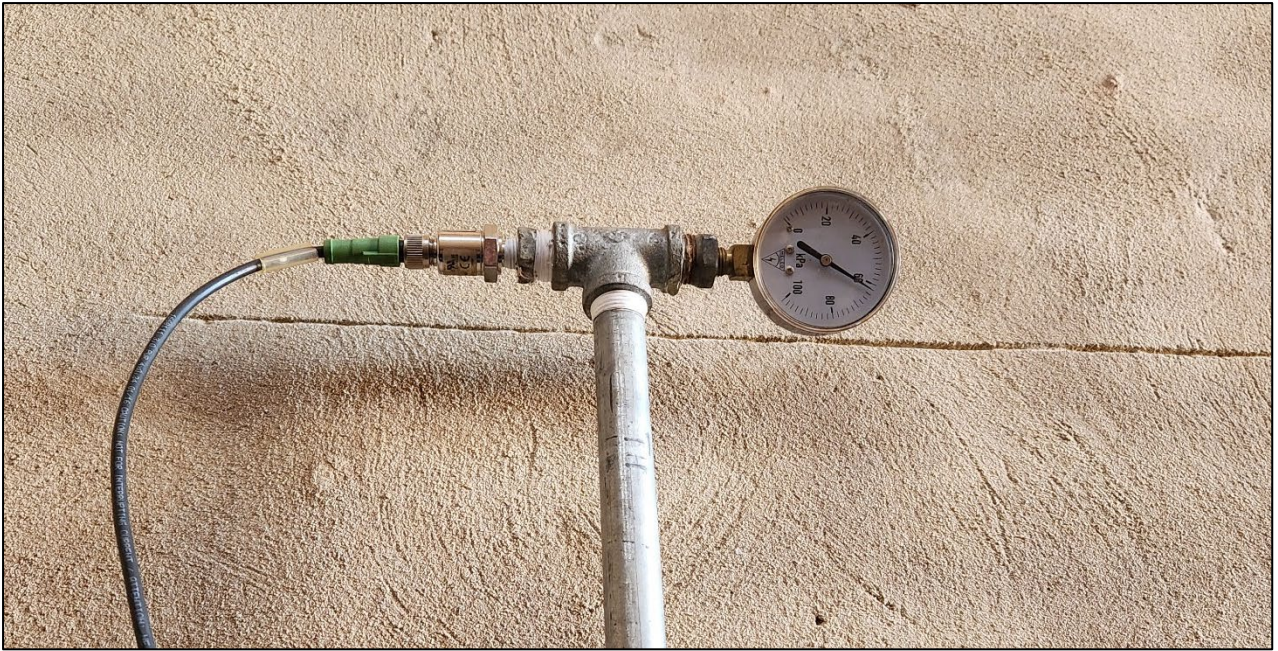

- **Figure 6-19: Pressure transducer measuring water level in reservoir**



Figure 6-20: Ultrasonic flow meter installed in Chamber C on inlet pipeline for additional verification of flow meter C-FM (407)



## 6.2.5

During the testing the water level in the reservoir was measured using two loggers and the flow was measured using an ultrasonic flow meter comparing this with the in-situ flow meter values.

### 6.2.5.1 HOBO U30 GSM logger with battery charger

A HOBO U30 GSM logger (Figure 6-21) was used. The system transmits data to the web via cellular communications for easy access from internet-enabled devices, however in this installation it was downloaded to a computer.

The battery chargers are rated for 240 V and 50 Hz input power and an input adapter were also acquired for each logger. The 12 bit, 4-20mA, adapters can be set to a switched input that extends the life of external batteries. It also provides a trigger signal for controlling power to attached external sensors, while offering digital filtering which improves measurement accuracy with 32 readings/sample and 60 Hz noise rejection.



(f) HOBO U30 GSM logger



(g) Battery charger

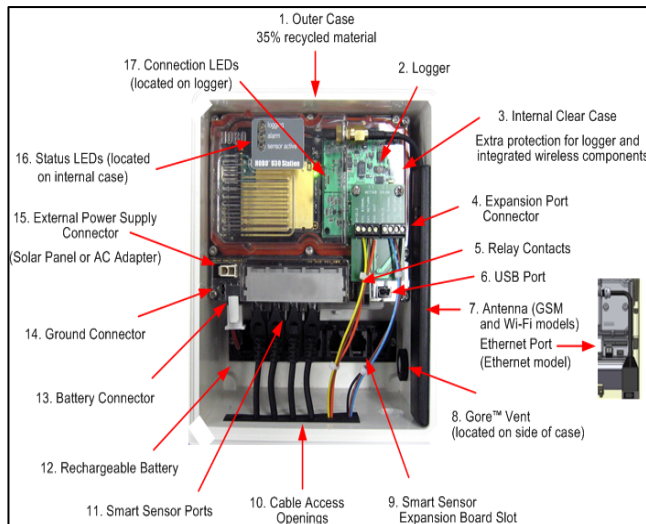

(h) U30 logger components



(i) Installed U30 logger

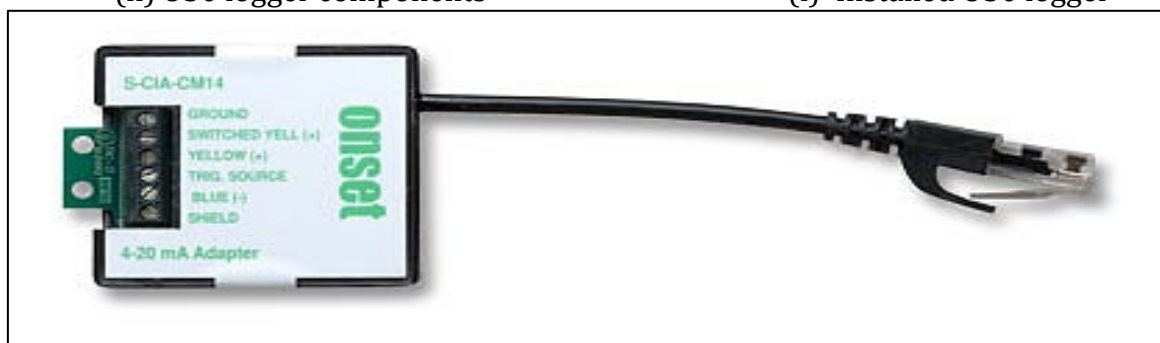

(j) 12 bit adapter

- **Figure 6-21: HOBO U30 GSM logger with battery charger**

### 6.2.5.2 HOBO Water Level Logger 9 m

A HOBO Water Level Logger was used with the data downloaded using an optic base station and HOBOWare Pro software (Figure 6-22).

The HOBO Water Level data loggers can be installed in freshwater canals, streams, rivers or lakes and can measure water levels with high accuracy, with no cumbersome vent tubes or desiccants to maintain.

The Optic USB Base Station and couplers will be used to offload data from the water level loggers. The Base Station connects to a computer via USB, while connecting to the logger via an appropriate coupler.

The 12 bit, 4-20mA, adapters can be set to a switched input that extends the life of external batteries. It also provides a trigger signal for controlling power to attached external sensors, while offering digital filtering which improves measurement accuracy with 32 readings/sample and 60 Hz noise rejection.

The HOBOWare Pro software can be used to Plot or export data to spreadsheets to conduct analysis necessary for your project. HOBOWare® Pro is easy to set up and its intuitive, point-and-click interface makes it simple to run. This data logging application is compatible with all HOBO data loggers and wireless data nodes.



(a) HOBO 9 m water level logger



(b) Optic base station

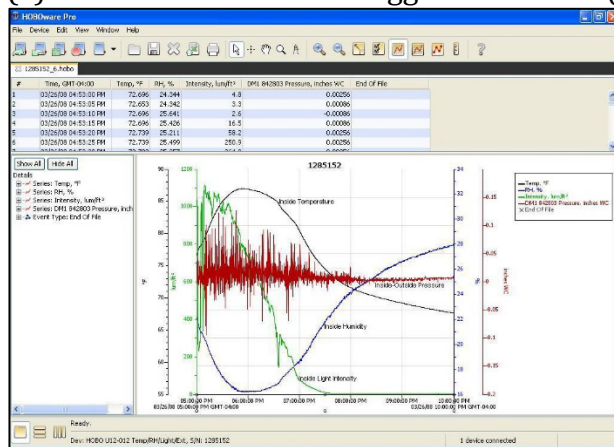

(c) HOBOWare Pro software

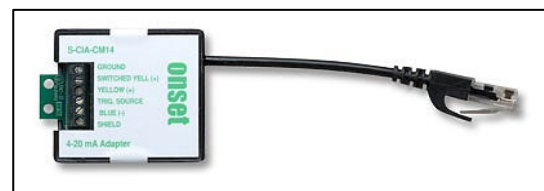

(d) 12 bit input adapter

- **Figure 6-22: HOBO U20 Water Level Logger 9 m**



### 6.2.5.3 Pressure measurement

Pressure was also measured using Gems pressure transducers, Figure 6-23, (ranging from 1-2 bar) capable of measuring the expected variance in pressure at the specific location.



- **Figure 6-23: Pressure transducers**

### 6.2.5.4 Flow meter (master meter)

An ultrasonic flow meter was purchased and utilised at the testing site. Data at a frequency of 5 Hz is recorded and stored on the portable flow meter and transmitted via serial cable to a computer.

The flow meter is a Flowmetrix ultrasonic flow meter (Model: SAFSONIC P PORTABLE ULTRASONIC FLOWMETER), Figure 6-24. It utilizes Middle sensor type (Model: M2) which can be installed on pipes ranging from 50-00 mm in diameter. It has a frequency range of 1 Hz.





- **Figure 6-24: Ultrasonic flow meter**



- **Figure 6-25: Inlet flow meter - C-FM (407)**





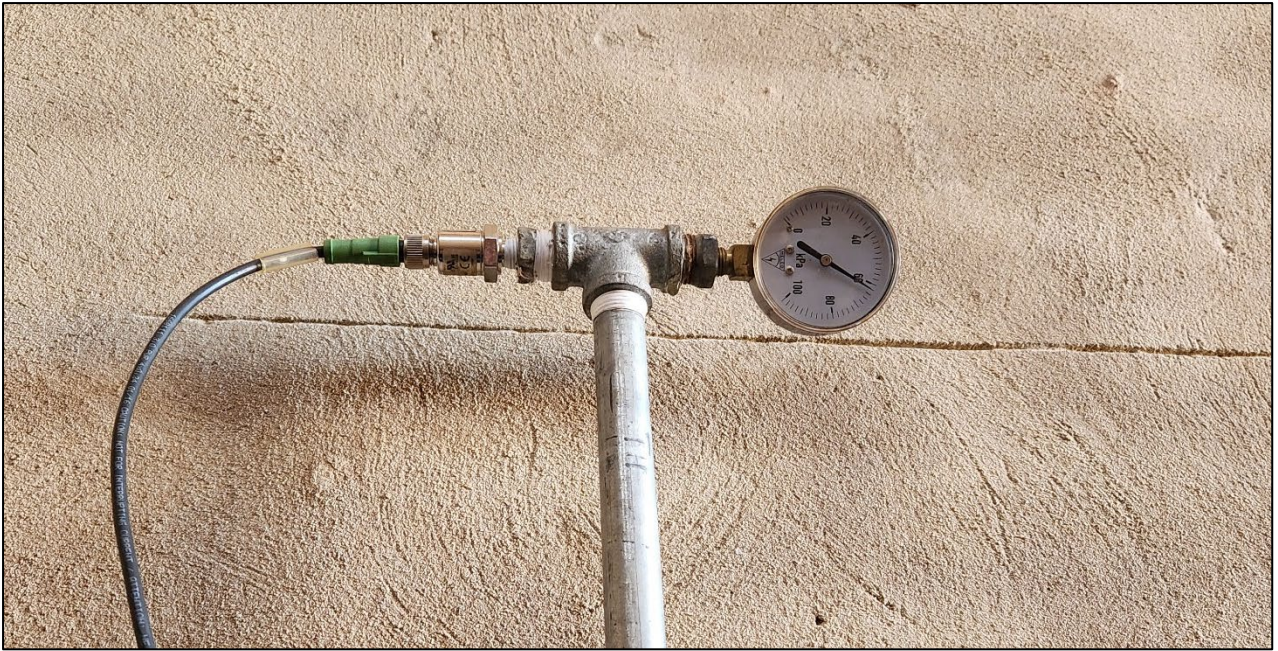

- **Figure 6-26: Pressure transducer measuring water level in reservoir**



- **Figure 6-27: Ultrasonic flow meter installed in Chamber C on inlet pipeline for additional verification of flow meter C-FM (407)**



## 6.3 PHASE 3: DATA ANALYSES

### 6.3.1 Data analyses – Test 1 - Inlet flow meter - C-FM (407)

The first test conducted was on the Inlet flow meter - C-FM (407). The average flow rates obtained during the testing phase is depicted in Figure 6-28 to Figure 6-30.

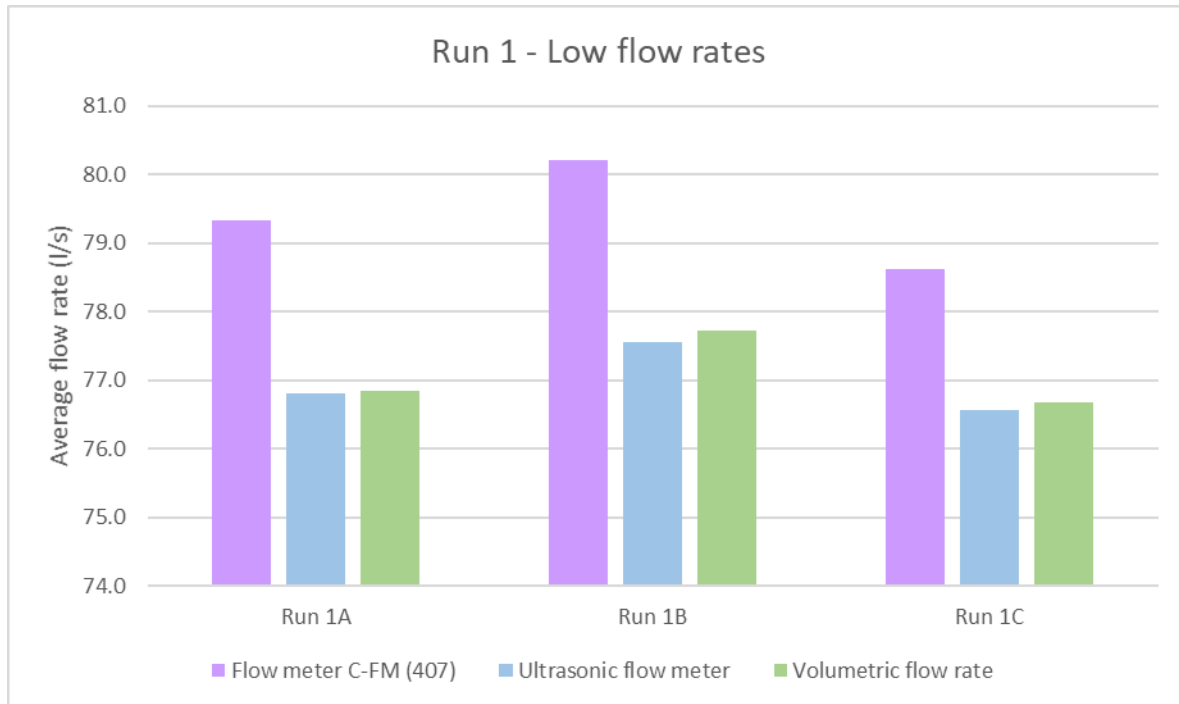

- **Figure 6-28: Average flow rate Test 1 - Run 1 (Low flows)**

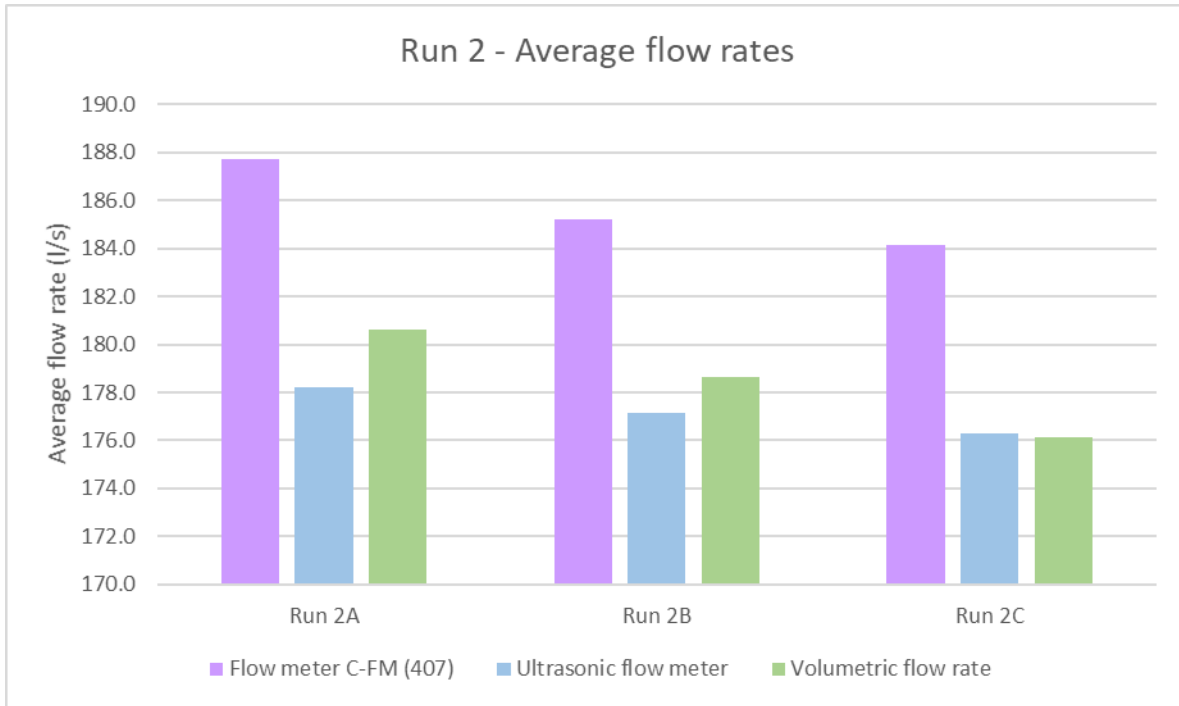

- **Figure 6-29: Average flow rate Test 1 - Run 1 (Average flows)**

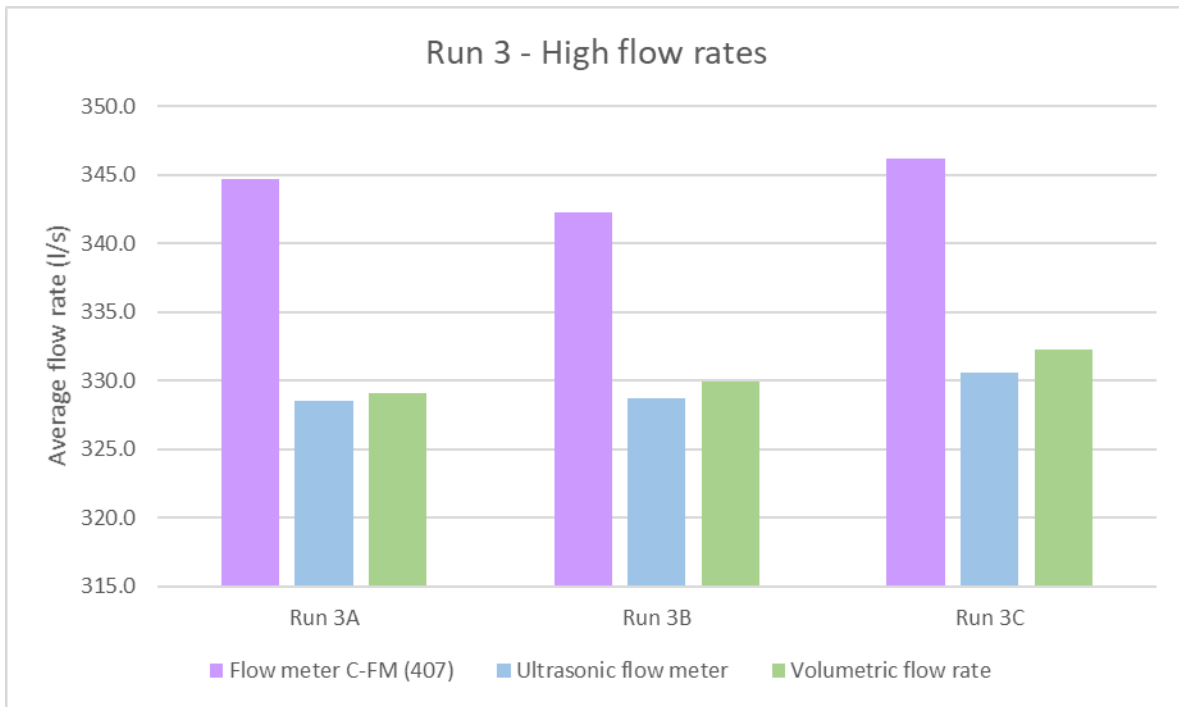

- **Figure 6-30: Average flow rate Test 1 - Run 1 (High flows)**

The difference in flow rates when comparing the C-FM (407) flow meter and the volumetric back calculated average flow rate is depicted in Figure 6-31. It ranges from 2.99% to 4.22% difference depending on the flow rate. In other words, the C-FM (407) overestimated the inflow into the reservoir by these percentages based on the average inflow rates.



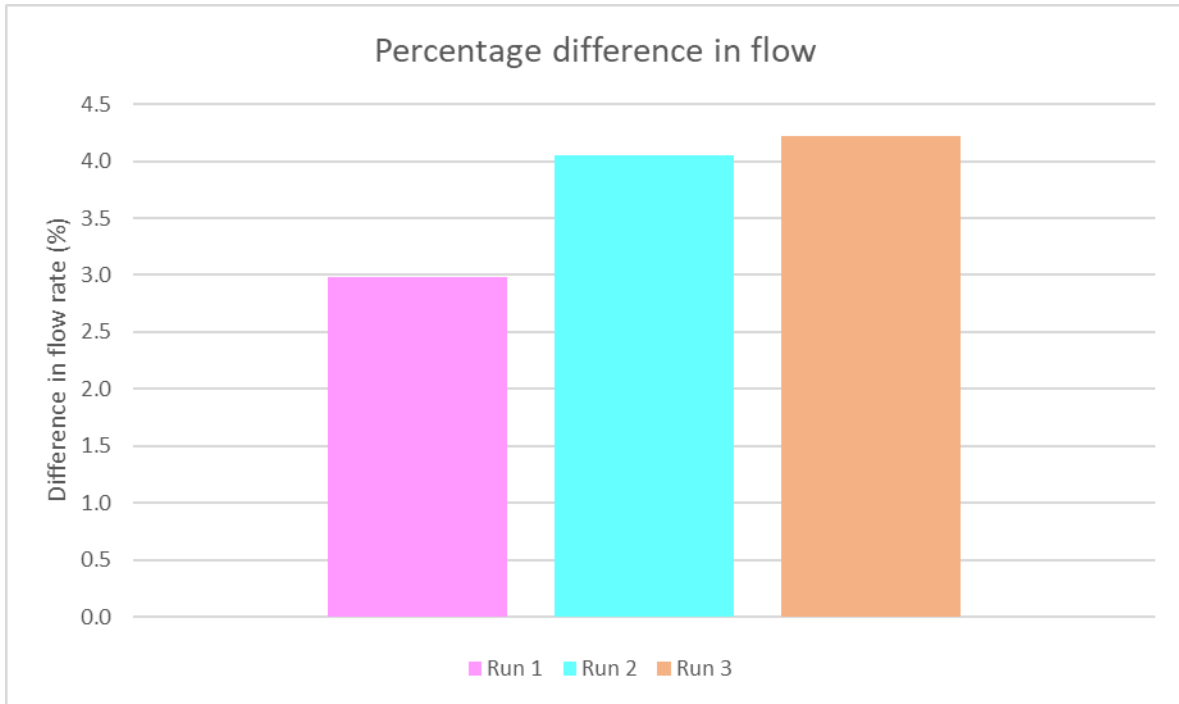

- **Figure 6-31: Differences in flow rates (Volumetric versus C-FM (407))**

### 6.3.2 Data analyses – Test 2 - Inlet flow meter - A-FM (128)

The second test conducted was on the outlet flow meter - A-FM (128). Only two distinct test periods could be tested (low and average flow rates). The average flow rates obtained during these testing phases are depicted in Figure 6-32 and Figure 6-33.

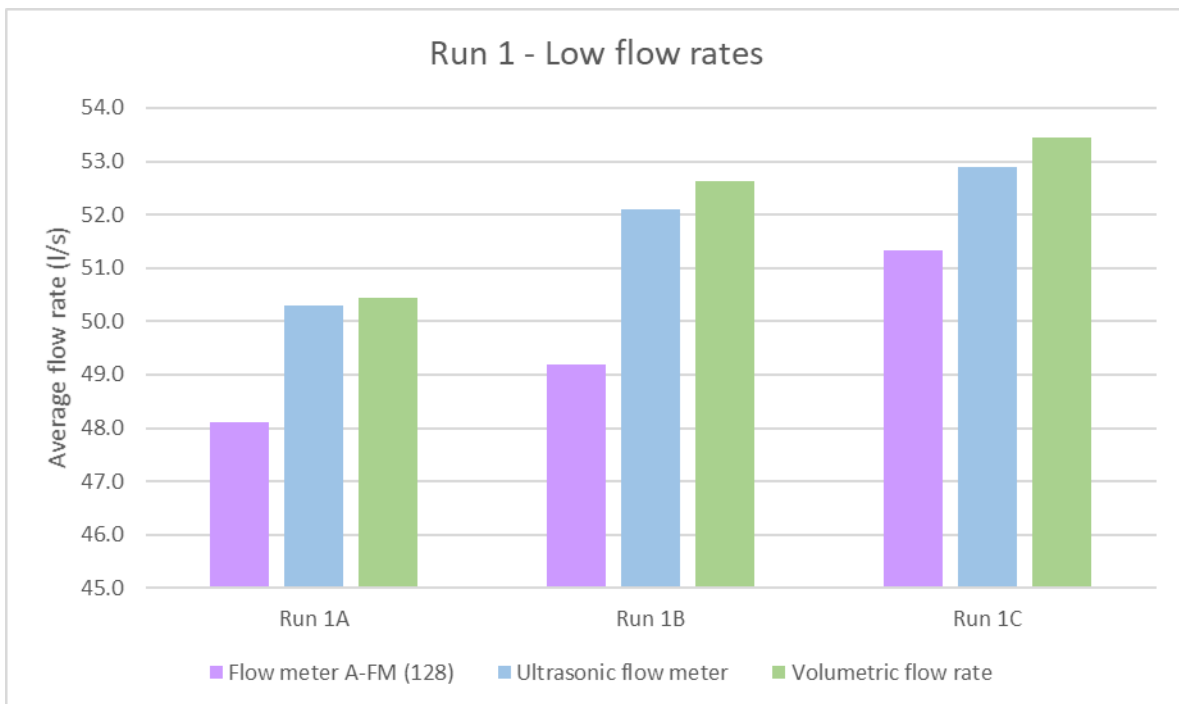

- **Figure 6-32: Average flow rate Test 2 - Run 1 (Low flows)**



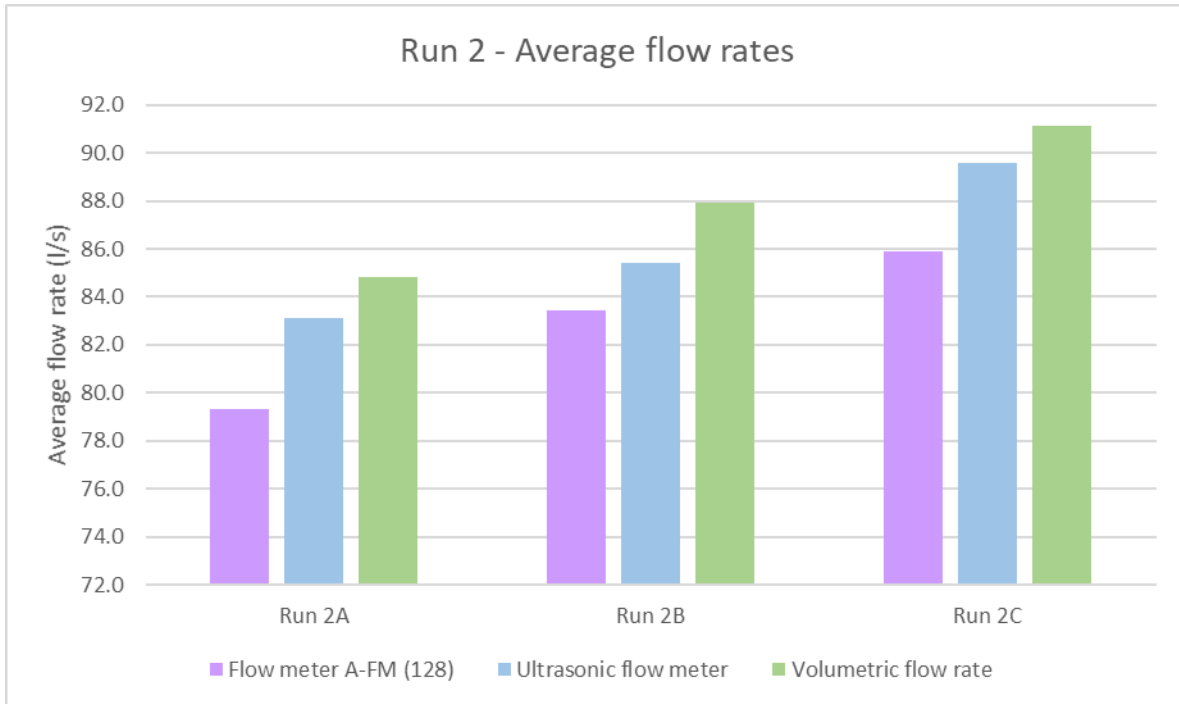

• **Figure 6-33: Average flow rate Test 2 - Run 1 (Average flows)**

These flows were less constant as it was based on the demand in the network which is supplied from this reservoir and thus durations during which recordings could be done was less. This also results in larger inaccuracies in the volumetric changes that could be measured.

The difference in flow rates when comparing the A-FM (128) flow meter and the volumetric back calculated flow rate is depicted in Figure 6-34. It ranges from 5.05% and 5.74% difference depending on the flow rate. In other words, the A-FM (128) under measured by these percentages based on the average outflow rates during each test run.



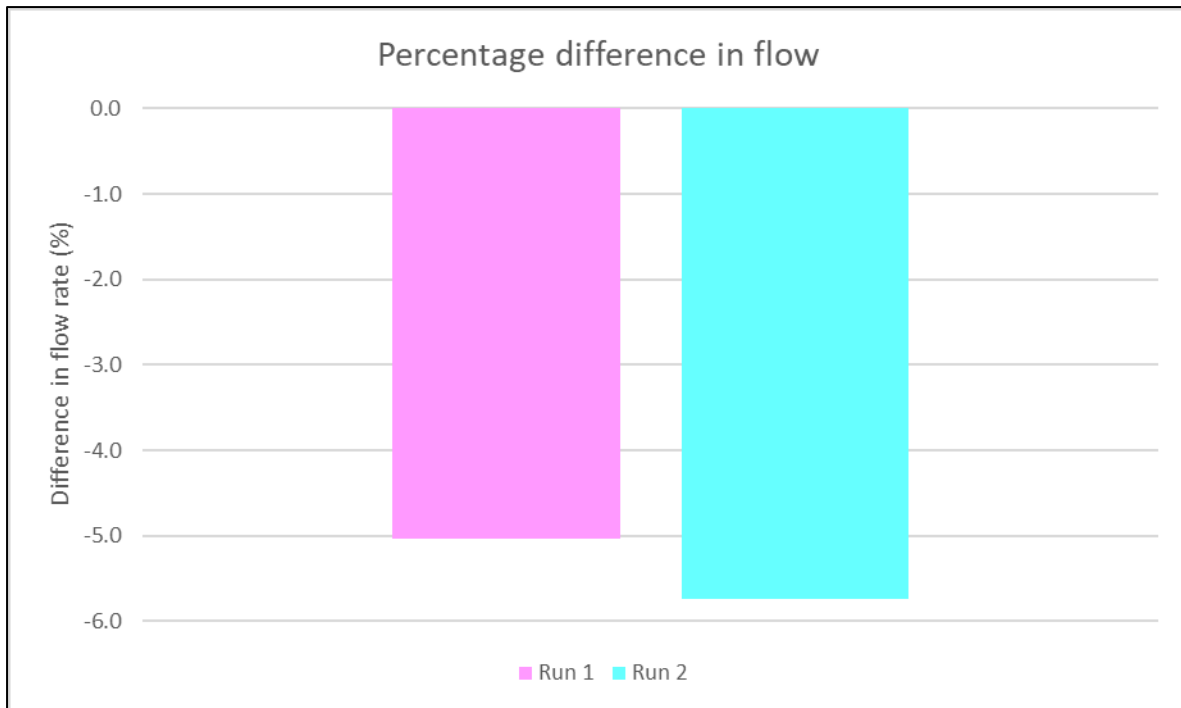

- **Figure 6-34: Differences in flow rates (Volumetric versus A-FM (128))**

It is important for accountability to accurately measure the outflow from the reservoir to determine unaccounted for water (UFW) or non-revenue water (NRW) to enable further water demand management interventions the potential.

The inaccuracy measured on the inflow is however more significant as it indicates a potential overpaying for the received water. This specific installation operates in such a manner that the flow is either zero (closed by the level control valve) or fully open operating at high flow rates. Based on the average supply to this reservoir complex of R4.1 million litres per annum and a typical tariff of R14.58/m<sup>3</sup> the inaccuracy of on average 4.22% (high flow rate range) could equate to an amount of R2.54 million/annum. This potential saving in expenditure could be achieved if the installation configuration is optimized and a more accurate flow meter is utilized.

## 7. VOLUMETRIC EVALUATION TOOL

The volumetric evaluation tool provides the user with a means to determine the accuracy of an in-situ flow meter through the usage in-situ and clamp-on or mobile measuring instruments. The sections to follow comprehensively discuss the the-by-step procedure involved in verifying the accuracy of an in-situ flow meters.

A guide is provided for each process of the tool guiding the user through the volumetric verification process and the parameters that needs to be defined.

### 7.1 PROJECT DEFINITION

The user is required to define the project details by clicking on **“Input analyses data”**. The defined project details are then pasted in the applicable cells as illustrated in Figure 7-1. The user can then proceed to the next sheet by clicking on **“Click to start process”**.

The screenshot displays the 'Project Definition' interface. At the top left is the University of Pretoria logo and the title 'In-Situ Verification of Bulk Meters Using Reservoir Volumetrics'. Below the title is a photograph of a large, multi-arched underground reservoir structure. To the right of the photograph is a list of project details:

Name of user	G Weststrate
Date of analyses	15/10/2023
Reservoir complex name	Pierre van Ryneveld
Reservoir structures	2

A bracket on the right side of this list is labeled 'Pasted project details'. Below the list is a legend: 'User input' is represented by a red line, and 'Calculations' is represented by a black line. In the project details, 'G Weststrate', '15/10/2023', 'Pierre van Ryneveld', and '2' are in red, while the other text is in black. At the top right, a blue box contains a numbered list: '1. Click to input project details' and '2. Click to proceed'. A blue arrow points from this box to a dashed blue box containing two buttons: 'Input analyses data' and 'Click to start process'.

• **Figure 7-1: Project definition**

It is important to note that all parameters indicated in **Red** requires input by the user. All calculations are indicated in **Black** and should not be altered.

## 7.2 SITE SELECTION

A short, yet comprehensive flow diagram is provided that assists the user in the site selection process. The provided diagram, illustrated in Figure 7-2, provides step-by-step processes that allows the user to determine whether the selected site is applicable for flow meter verification. If a selected reservoir site is deemed suitable for verification the user can then click on **“Proceed with verification”**.

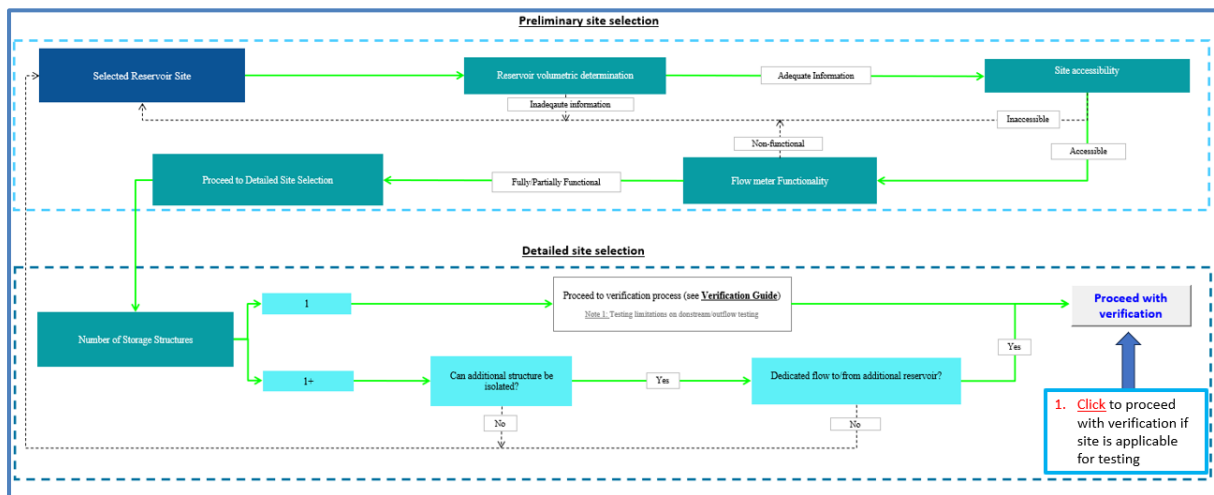

• **Figure 7-2: Site selection process diagram**

The main categories needed to be defined which ultimately determines the applicability of the reservoir site to verification are:

- Reservoir volumetric characteristics:
  - As-built drawings or any other means (3D rendering) must be available to determine the volumetric characteristics of the reservoir.
- Site accessibility:
  - The site needs to be accessible as physical dimensions and readings must be taken. It is also important that the site be accessible as measuring equipment need to be installed with data to be retrieved frequently.
- Flow meter functionality:
  - Flow meters must be functional in order to verify its accuracy.
- Amount of storage structures:
  - This is important to define as this has an impact on the testing procedure. Impact on the downstream consumers is significantly reduced if 2 storage structures exist and one can be isolated for testing whilst the remaining structure can provide uninterrupted supply.

This process mostly requires input from the user to determine the applicability of the site. as this process is merely a guide. In addition, a flow meter verification guide is also provided that depicts the steps required to isolate a specific flow meter for verification as illustrated in Figure 7-3,



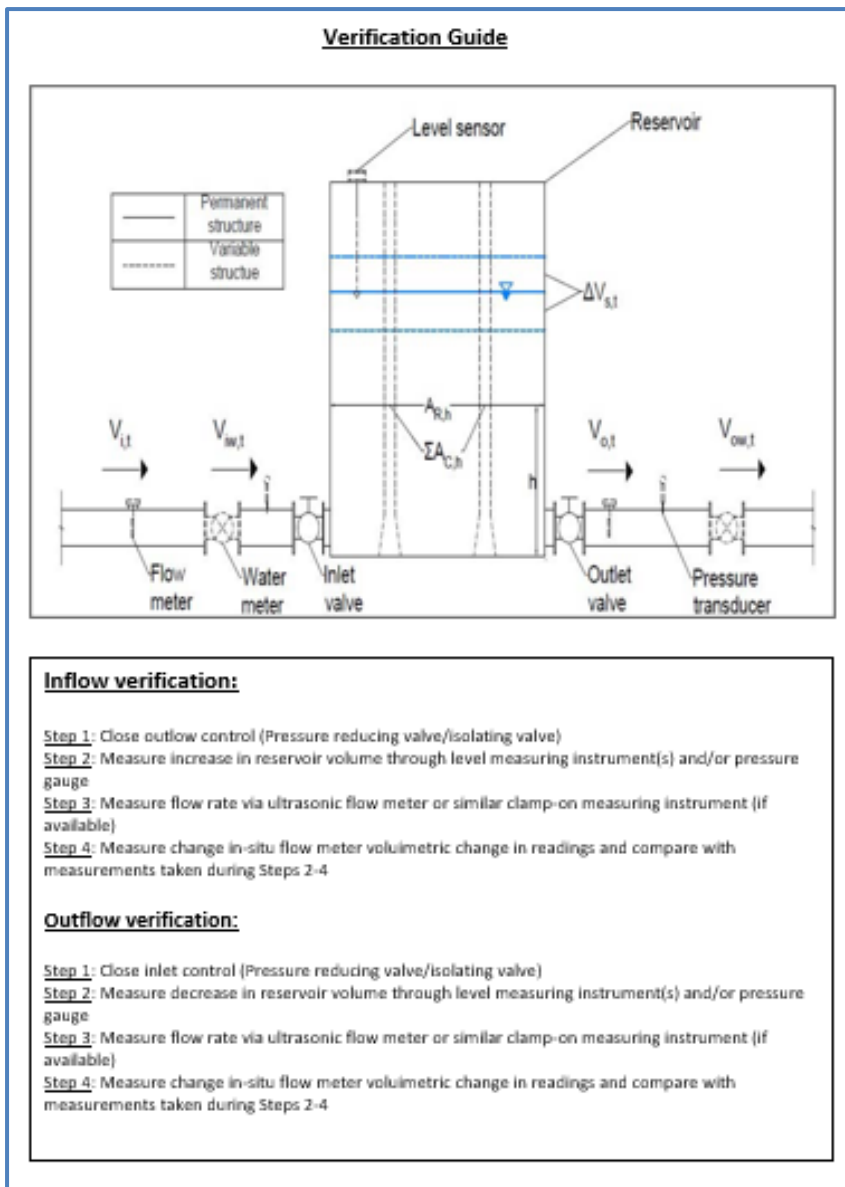

- **Figure 7-3: Flow meter verification guide**

### 7.3 RESERVOIR VOLUMETRIC CHARACTERISATION

The reservoir volumetric characterisation process prompts the user to input the necessary parameters comprising the:

- Reservoir capacity and description;
- Reservoir diameter;
- Number of internal columns, shape and dimensions thereof; and
- Reservoir full supply level (FSL)

The input defined by the user is then used to calculate the corresponding netto volume at incremental heights as illustrated in Figure 7-4. This is done by subtracting the total area of the columns from the total reservoir area. Once all the parameters are defined, the user is allowed to proceed by clicking on **“Proceed”**.



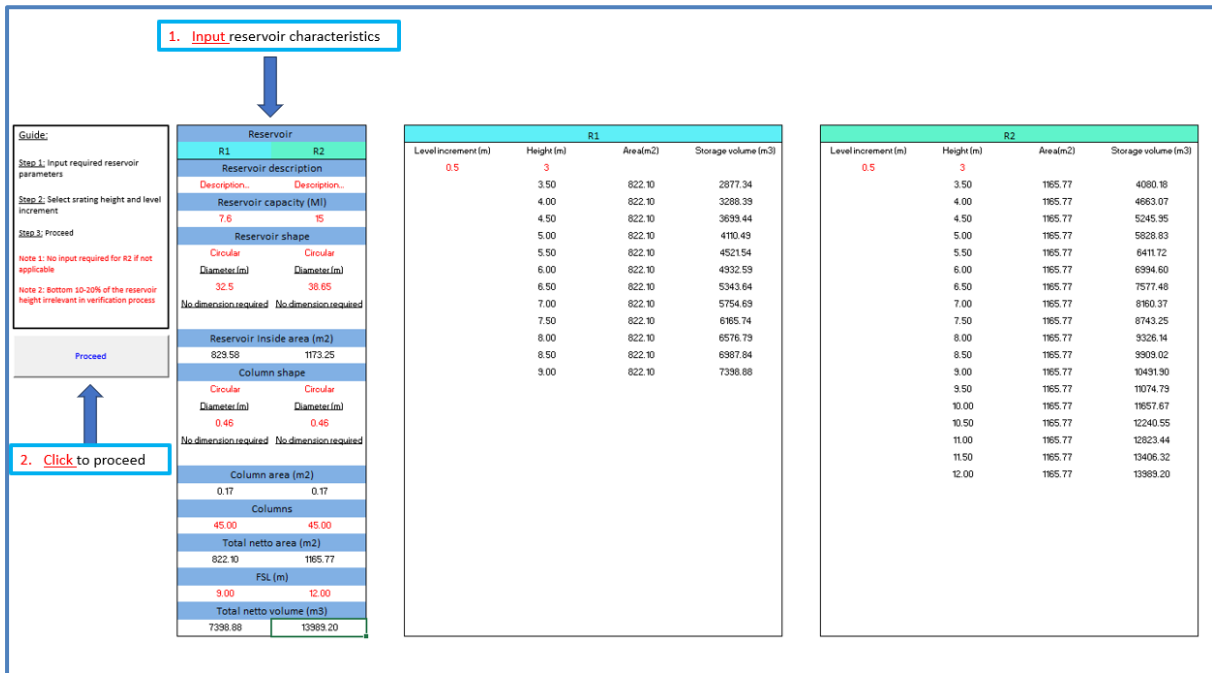

• **Figure 7-4: Reservoir volumetric characterisation**

## 7.4 FLOW METER CHARACTERISATION

SANS 1529-4:2004 provides guidance on the minimum, transitional, and peak flow requirements for different diameter and class flow meters as illustrated in Figure 7-5.

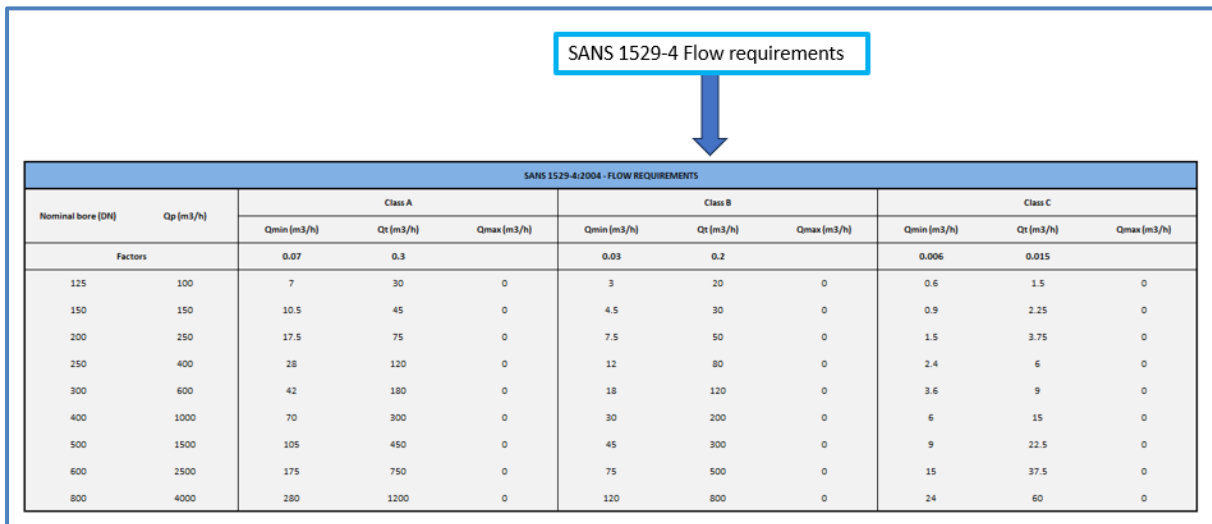

• **Figure 7-5: SANS 1529-4 flow requirements and flow meter characterisations**

For a selected diameter and class, an error envelope can be extracted as illustrated in Figure 7-6.



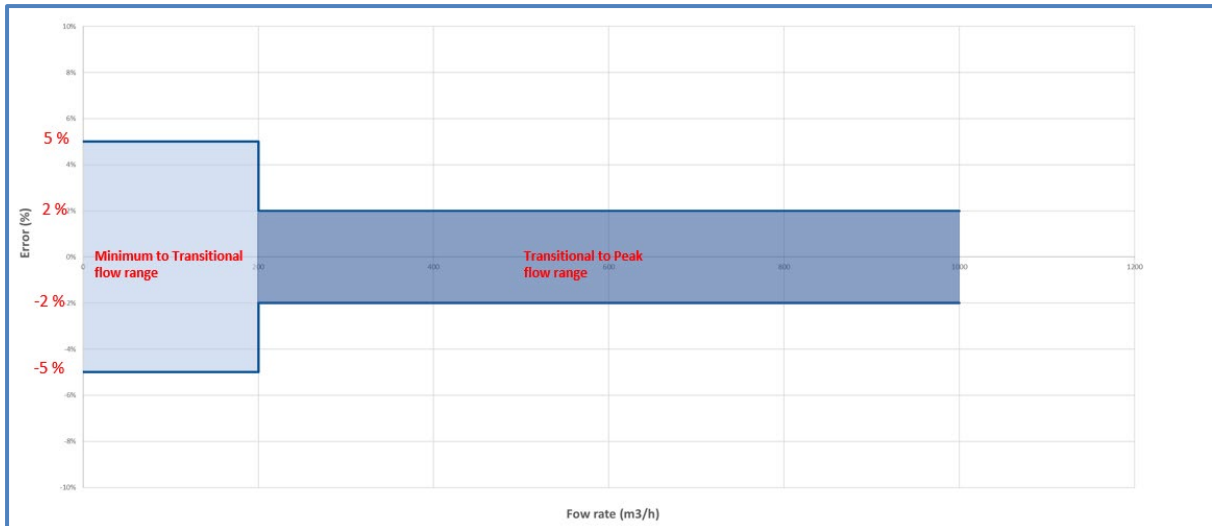

- **Figure 7-6: Typical error envelope**

SANS 1529-4:2004 requires a flow meter to not exceed an accuracy of  $\pm 5\%$  for flow ranges between the minimum to transitional flow range. For flow ranges exceeding this, a maximum allowable error of  $\pm 2\%$  should be maintained as illustrated in Figure 7-6.

The user is then required to input the necessary parameters that include, flow meter description, diameter, meter number (if available), and meter class as illustrated in Figure 7-7. The resultant flow requirements are then extracted from SANS 1529-4:2004 with the corresponding error envelope extracted. The user can then click on **Proceed**.

Reservoir	Control (Inflow/Outflow)	Meter type	Nominal diameter, DN (mm)	Meter number	Meter class	See figure for error envelopes			
						Qp (m3/h)	Qmin (m3/h)	Qt (m3/h)	Qmax (m3/h)
R1	Outflow	Meincke WPD Cosmos Turbine DN300	300	128	Class B	600	18	120	0
	Inflow	Meincke WPD Cosmos Turbine DN300	300	447	Class B	600	18	120	0
R2	Outflow	DN400	300	442	Class B	600	18	120	0
	Inflow	Meincke WPD Cosmos Turbine DN300	400	402	Class B	1000	30	200	0

- **Figure 7-7: Flow meter description**

## 7.5 DATA MEASURING

The verification procedure, in principle, compares the flow volumes of different measuring instrumentation to those observed from the in-situ flow meter. The methods of additional flow measuring used are:

- Reservoir level measurements through a level logger from which data can be retrieved;



- Pressure head measurements through in-situ pressure gauges connected to a logger of which data can be retrieved; and
- Flow volume measuring through clamp-on instruments (ultrasonic flow meter).

Measurements taken from the level logger and pressure gauge/transducer can be converted to flow volumes given the defined reservoir volumetric characteristics and compared to the clamp-on instrument. These can then be compared with the flow volumes given by the in-situ flow meter.

## 7.6 RESERVOIR LEVEL MEASURING

### 7.6.1 Logging frequency

In order to measure at a high, yet achievable accuracy, and to allow for the uncertainty in the reservoir volumetric determination, the frequency in reservoir level logging should be sufficiently large enough to account for these uncertainties. The user is prompted to select test flows that relates to a flow range with a **low flow rating** as well as **high flow rating**. The user is also required to specify the rated accuracy of the level logger as illustrated in Figure 7-8. The resultant test flow **validity** and **logging frequency** is then determined.

Reservoir	Net area m <sup>2</sup>	Control	Prescribed flow range m <sup>3</sup> /h		Description	Selected flow		Level measuring accuracy		Error %	Height change m	Volume change m <sup>3</sup>	Required logging freq.
			Lower limit	Upper limit		m <sup>3</sup> /h	Validity	mm	mm				
R1	622.10	Outflow	10.00	120.00	Low flow rating	30.00	108	Valid	1	Tc	0.10	62.2	46
			120.00	600.00	High flow rating	120.00	432	Valid	1	Tc	0.10	62.2	11
		Inflow	10.00	120.00	Low flow rating	15.00	54	Valid	1	Tc	0.10	62.2	31
			120.00	600.00	High flow rating	60.00	288	Valid	1	Tc	0.10	62.2	17
R2	1865.77	Outflow	10.00	120.00	Low flow rating	30.00	108	Valid	1	Tc	0.10	186.6	65
			120.00	600.00	High flow rating	120.00	432	Valid	1	Tc	0.10	186.6	16
		Inflow	30.00	200.00	Low flow rating	50.00	180	Valid	1	Tc	0.10	186.6	39
			200.00	1000.00	High flow rating	150.00	540	Valid	1	Tc	0.10	186.6	13

- **Figure 7-8: Required level logging frequency**

The user is not required to select test flows for a second reservoir (R2) if not applicable. However, if R1 and R2 is used and invalid test flows are selected for both, the user will be notified as illustrated in Figure 7-9 and not permitted to **“Proceed”**. The same message will appear if the required accuracies are not defined.

Prescribed flow range - Upper limit	Description	Selected flow		
/h		l/s	m3/h	Validity
120.00	Low flow rating	0.00	0	Invalid
600.00	High flow rating	120.00	432	Valid
200.00	Low flow rating	15.00	54	Valid
1000.00	High flow rating	80.00	288	Valid
120.00	Low flow rating	0.00	0	Invalid
600.00	High flow rating	120.00	432	Valid
200.00	Low flow rating	50.00	180	Valid
1000.00	High flow rating	150.00	540	Valid

• **Figure 7-9: Error notification**

### 7.6.2 Level logging

The user is required to import the logging output data in .CSV format. The output .CSV file should contain the **Date, Time, and Pressure (kPa)** readings logged during the time of testing. The user is also allowed to clear data in the case of an error made. Also provided are the status of the logging periods which are indicated as **Complete** if the required logging frequency are met and **Incomplete** in the case where frequencies are not met. This is the case for inflow and outflow testing. It is also not required by the user to import data for a second reservoir if not applicable. The required input from the user is illustrated in Figure 7-10.

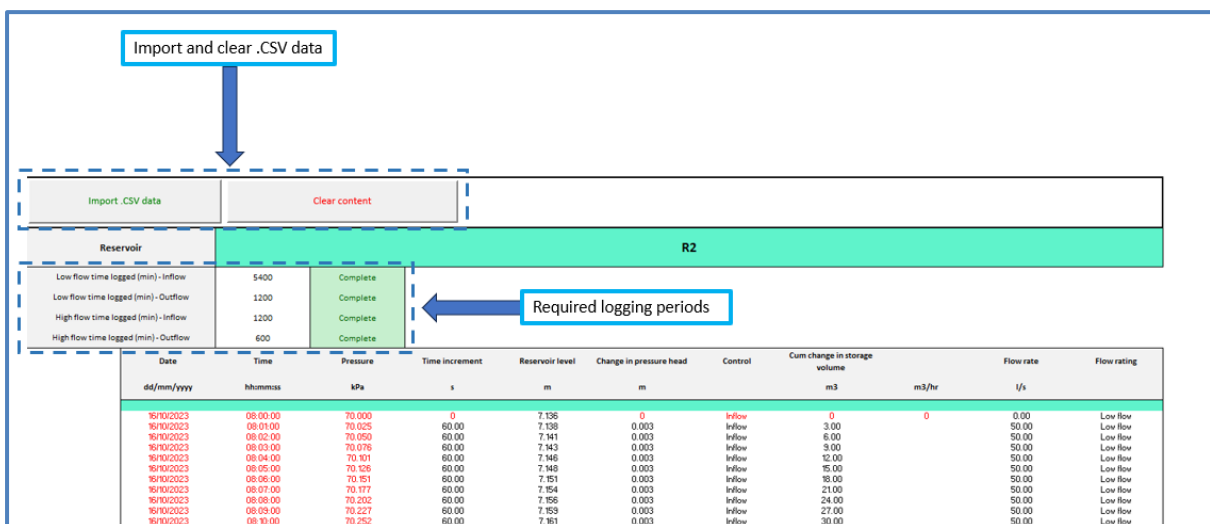

• **Figure 7-10: Level logging analyses**

Once the relevant data is imported, the data is automatically subdivided between **inflow**, **outflow** and **low flow** rating and **high flow** rating. The user can then click on **“Proceed”**. Graphs depicting the change in reservoir level and corresponding flow rate are also provided for each reservoir.



## 7.7 PRESSURE MEASUREMENTS

The second verification method involves the usage of in-situ pressure gauges to determine the current reservoir level and changes thereof. A logger is linked to the pressure gauge to log the changes in reservoir level.

The user is required to import the logging output data in .CSV format. The output .CSV file should contain the **Date, Time, and Transducer output (mA)** readings logged during the time of testing. The user is also allowed to clear data in the case of an error made. The required input from the user is illustrated in Figure 7-11.

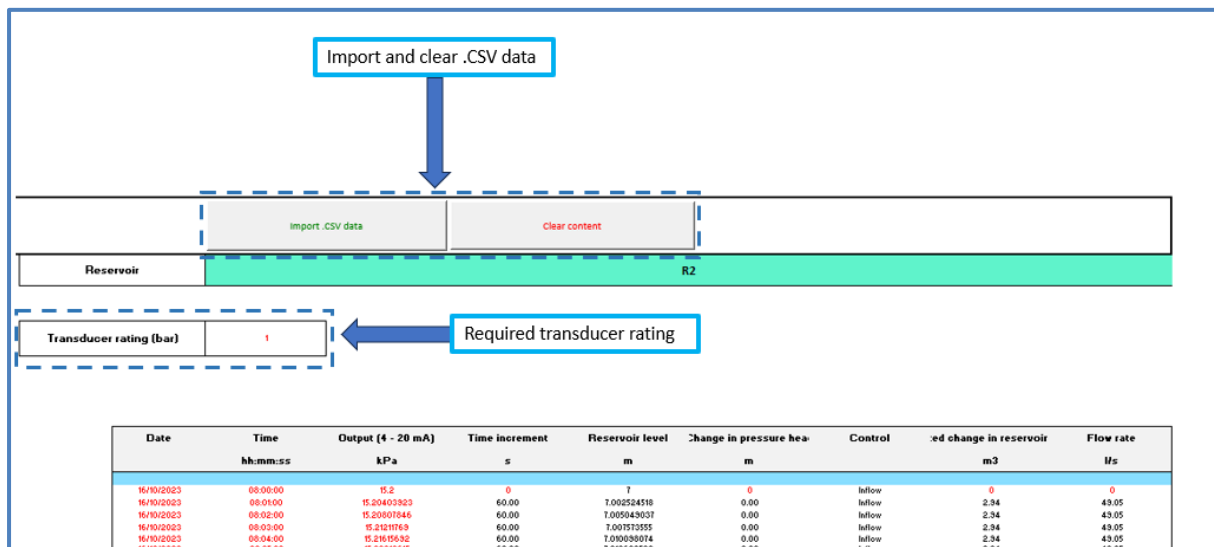

• **Figure 7-11: Pressure logging analyses**

Once the relevant data is imported, the data is automatically subdivided between **inflow**, **outflow** and **low flow** rating and **high flow** rating. Graphs depicting the change in reservoir level and corresponding flow rate are also provided for each reservoir.

## 7.8 Ultrasonic flow measuring

If possible, an ultrasonic flow meter capable of highly accurate flow measurements can be installed to further verify the accuracy of the in-situ flow meter. The user is then required to import the data from a file in .CSV format as shown in Figure 7-12. The output \*.CSV file should contain the **Date, Time, and Flow rate (l/s)**.

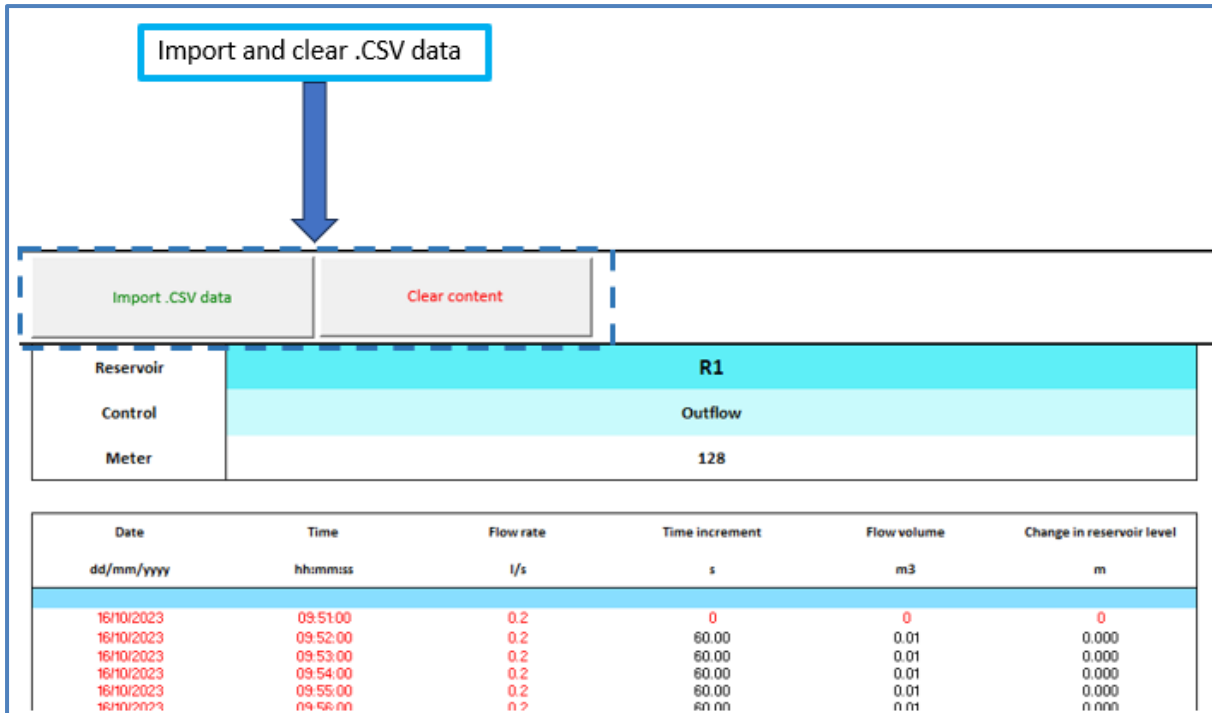

- **Figure 7-12: Ultrasonic flow analyses**

## 7.9 MANUAL READINGS

The manual readings taken at regular intervals of each meter is logged as shown in Figure 7-13. The user can click on **Proceed**.

Log manual readings

Reservoir	R1							
Control	Outflow							
Meter	128							
Date	Interval	Logging time	Time increme	meter reading	Total volume	Flow rate	Flow rate	Flow rating
dd/mm/yyyy			s	m3	m3	l/s	m3/h	
12/10/2023	00:05:00	10:00:00	0.00	500	0	0.00	0	Low flow
12/10/2023		10:05:00	300.00	508.6	8.6	28.67	103.2	Low flow
12/10/2023		10:10:00	300.00	517.2	17.2	28.67	103.2	Low flow
12/10/2023		10:15:00	300.00	525.8	25.8	28.67	103.2	Low flow
12/10/2023		10:20:00	300.00	534.4	34.4	28.67	103.2	Low flow
12/10/2023		10:25:00	300.00	543	43	28.67	103.2	Low flow
12/10/2023		10:30:00	300.00	551.6	51.6	28.67	103.2	Low flow
12/10/2023		10:35:00	300.00	560.2	60.2	28.67	103.2	Low flow
12/10/2023		10:40:00	300.00	568.8	68.8	28.67	103.2	Low flow
12/10/2023		10:45:00	300.00	577.4	77.4	28.67	103.2	Low flow
12/10/2023		10:50:00	300.00	612.7	112.7	117.67	423.6	High flow
12/10/2023		10:55:00	300.00	648	148	117.67	423.6	High flow
12/10/2023		11:00:00	300.00	683.3	183.3	117.67	423.6	High flow
12/10/2023		11:05:00	300.00	718.6	218.6	117.67	423.6	High flow

• Figure 7-13: Manual in-situ flow logging

## 7.10 FLOW METER VERIFICATION

The verification process only requires the user to select an analyses interval. The data logged from the relevant measuring methods are automatically imported and compared with the relevant errors calculated. **Error 1** involves the difference between the in-situ flow meter and level logger, **Error 2** the difference between the in-situ flow meter and pressure transducer, and **Error 3** the difference between the in-situ flow meter and ultrasonic flow meter. A corresponding **Average error** is then calculated to be used in the proceeding processes.

Interval

Reservoir	R1																
Control	Inflow																
Meter	447																
Analysis interval	Logging time	Manual Meter Readings		Level logger			Error 1	Pressure transducer			Error 2	UFM		Error 3	Average flow rate	Average error	
dd/mm/yyyy		Change in volume	Flow rate	Control	Change in storage	Flow rate	%	Control	Change in storage	Flow rate	%	Flow rate	Flow rate	%	Flow range	m3/h	%
		m <sup>3</sup>	m3/hr		m <sup>3</sup>	m3/hr	%		m <sup>3</sup>	m3/hr	%	l/s	m3/h	%			
00:05:00	00:00:00	0.00	0.00	below	0.00	0.00	0.0%	0.00	0.00	0.00	0%	0.00	0.00	0%	Low flow	0.00	0.0%
	00:05:00	3.00	60.00	below	4.00	34.00	11.1%	0.00	0.00	0.00	0%	0.00	0.00	0%	Low flow	10.00	11.1%
	00:10:00	10.00	60.00	below	3.00	54.00	11.1%	0.00	0.00	0.00	0%	0.00	0.00	0%	Low flow	10.00	11.1%
	00:15:00	15.00	60.00	below	13.00	54.00	11.1%	0.00	0.00	0.00	0%	0.00	0.00	0%	Low flow	10.00	11.1%
	00:20:00	20.00	60.00	below	10.00	54.00	11.1%	0.00	0.00	0.00	0%	0.00	0.00	0%	Low flow	10.00	11.1%
	00:25:00	25.00	60.00	below	20.00	54.00	11.1%	0.00	0.00	0.00	0%	0.00	0.00	0%	Low flow	10.00	11.1%
	00:30:00	30.00	60.00	below	27.00	54.00	11.1%	0.00	0.00	0.00	0%	0.00	0.00	0%	Low flow	10.00	11.1%
	00:35:00	35.00	60.00	below	24.00	54.00	11.1%	0.00	0.00	0.00	0%	0.00	0.00	0%	Low flow	10.00	11.1%

• Figure 7-14: Flow meter verification



## 7.11 FINANCIAL MODEL

The purpose of the financial model is to emphasise the economic impact of an inaccurate flow meter. The user is firstly required to define the required parameters associated with the revenue generation flow meter which involves defining the period of **High flow** rating, normally between the hours of 06:00 and 09:00 in the morning and 16:00 and 20:00 in the evening and **Low flow** periods in the remainder of the day. This is usually extracted from historical flow record. If not available, a high flow period of 8 hours and low flow period of 16 hours can be used as default as illustrated in Figure 7-15. The user is also required to define the bulk water rate.

Flow period breakdown				Accuracy post-remedial action									
Reservoir Control Meter	R1												
Bulk water rate (R/m <sup>3</sup> )	128												
Revenue													
Flow rating	Average flow rate	Flow period (h)	Daily flow volume	Pre-remedial action			Post-remedial action			Post-remedial action			
				Average error	Actual generated flow	Meter generated revenue	Difference	Flow error reduction	Reduced error	Actual generated flow	Meter generated revenue	Difference	
	m <sup>3</sup> /h	h/day	m <sup>3</sup> /day	%	R/day	R/day	R/day	%	%	R/day	R/day	R/day	
Low flow	166.2	16.0	2559.6	-21.1%	R26,568.2	R20,816.3	-R5,751.9	90%	-2.8%	R26,568.2	R26,011.0	-R557.2	
High flow	282.2	8.0	1301.3	15.3%	R19,305.0	R22,041.6	R2,732.6	90%	15%	R19,305.0	R19,402.1	R97.1	
Totals						R45,873.2	R42,857.9	-R3,015.3			R45,873.2	R45,413.1	-R460.1
							Utility revenue loss				Utility revenue loss		

• Figure 7-15: Flow meter revenue status

From this input it is determined whether the accuracy of the meter results in revenue loss to the utility or the municipality. In this case it will be indicated as **Utility Revenue loss** or **No Revenue loss** if the accuracy of the meter results in no revenue loss to the utility or municipality.

Should remedial action be required or pursued in the case of the flow meter indicating accuracies that results in revenue loss, the user is firstly required to input a conservative reduction in the flow meter accuracy as illustrated in Figure 7-15. Secondly, the user is required to incorporate remedial action capital costs that can be incurred as illustrated in Figure 7-16.

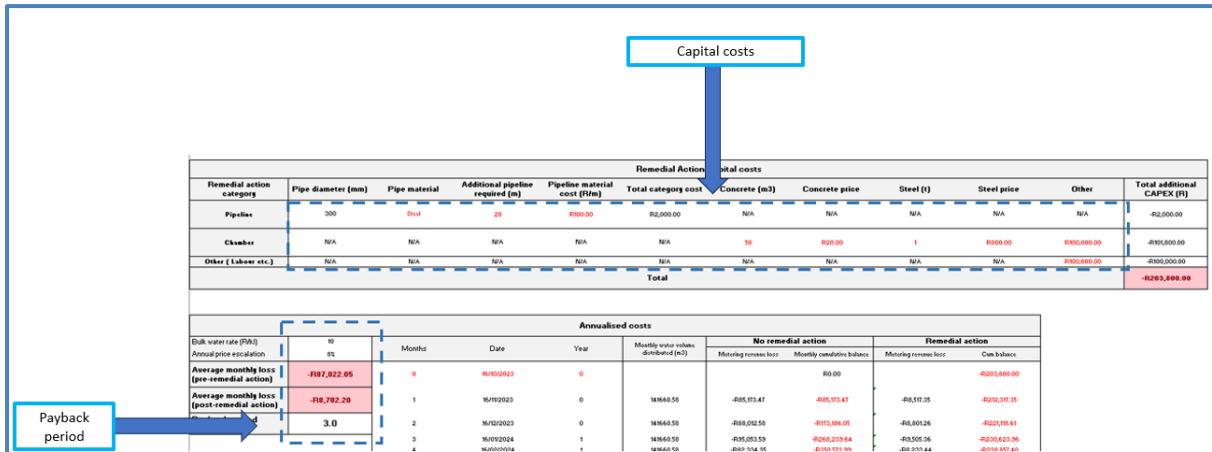

• **Figure 7-16: Remedial action CAPEX and Payback period**

Remedial costs include alterations to the pipeline for example increasing the distance between the in-situ flow meter and other components such as isolating valves, bends or strainers upstream or downstream of the flow meter. These components, if situated too close to the flow meter could impact meter accuracy. Remedial actions can also include alterations to the chamber size, requiring additional construction materials. Any other items such as labour costs can also form part of the remedial costs.

Based on the above inputs, a payback period is calculated which will inform the utility or municipality.



## 8. CONCLUSIONS

Sustainable water use is well defined the world over. Water utilities are faced with sustainability issues at almost every location of the water distribution system. With limited and stretched budgets, municipalities are faced with an issue where, metering helps the municipality in accounting for water resources in the water distribution system. Unfortunately, meters lose accuracy and the budgets and human capital to keep the meter performance high are often not available.

This study aimed to address these challenges by identifying optimal methods for determining reservoir volumetric characteristics, quantifying water losses, developing an innovative testing method for bulk water meters, and raising awareness about water loss issues. The literature review underscores the importance of accurate metering in managing water resources, identifying losses, and making informed decisions. Challenges in water loss reduction programs include poor design, incomplete implementation, and underestimation of difficulties. Successful interventions require a systematic approach tailored to the specific problems of each water supply system, emphasizing the importance of quantifying water loss to guide remedial actions.

Water metering is crucial for measuring water usage accurately. Meters come in various types, including mechanical (volumetric, inferential, and combination meters), electromagnetic, and ultrasonic, each with distinct features and applications.

Each meter type has advantages and limitations, making them suitable for different applications based on factors such as accuracy requirements, flow conditions, and water quality. Understanding these distinctions is essential for selecting the appropriate meter for specific water management needs.

Meter applications in water utilities are vital for accurate billing and monitoring. They are strategically placed throughout the supply and distribution infrastructure to measure various points such as raw water withdrawals, clean water production, connection points, and consumer usage. Installation considerations include complying with manufacturer recommendations, ensuring proper flow direction, and maintaining water supply.

Meter calibration is crucial for confirming performance, quality control, and compliance with legal requirements. Various methods such as gravimetric, volumetric and master meters are used for calibration. Testing methods include laboratory and in-situ verification. In-situ methods like master or reference meters, tracer methods, and on-site volumetric or gravimetric methods offer practical solutions for verifying meter accuracy in the field. Despite limitations in field testing accuracy compared to laboratory calibration, in-situ verification remains an important aspect of water meter management and maintenance.



The Water Meter Calibration Using Reservoir Volumetric Characteristics (WMCURVC) procedure is proposed, which follows defined steps like defining reservoir volumetric characteristics, installing measuring devices, conducting a step-by-step method to test flow through the meter and analysing the data. The process involves systematically filling or emptying the reservoir, for specific time periods, at different flow rates and measuring the volumetric change and comparing this with the flow meter readings for these periods. The Volumetric Evaluation Tool offers a systematic approach for assessing the accuracy of in-situ flow meters using various measuring instruments. It guides users through a step-by-step process, starting with project definition, site selection, defining key parameters such as reservoir characteristics, site accessibility, flow meter functionality, and storage structures to ensure accurate verification. Reservoir volumetric characterization involves inputting parameters such as capacity, diameter, internal columns, and minimum operating and full supply level to calculate net volume at incremental heights. Flow meter characterization follows SANS 1529-4:2004 guidelines, determining error envelopes based on meter description, diameter, number, and class. The financial model assesses the economic impact of inaccurate flow meters, allowing users to define revenue generation parameters and potential revenue loss due to meter inaccuracies. Remedial action costs and payback periods are calculated, aiding utilities in decision-making.

It is important to highlight that the testing procedure determines the potential error that results from the meter and meter installation configuration. As many meters are not installed according to the manufacturers or local authorities' specifications the error in measurement can only be attributed to the system and not necessarily directly to the meter inaccuracy.

The Pierre van Ryneveld Reservoir complex in the City of Tshwane served as a case study, highlighting the importance of functional water meters, the installation configuration, reservoir storage characteristics, and appropriate testing equipment installation. The field tests indicated that there was a discrepancy between the existing flow meter and the values obtained from the ultrasonic flow meter and the volumetric evaluation. The analyses indicated a possible 2.99% to 4.22% difference depending on the flow rate in which the existing flow meter overestimated the actual volume. Based on the average supply to this reservoir complex of R4.1 million litres per annum and a typical tariff of R14.58/m<sup>3</sup> the inaccuracy of on average 4.22% (high flow rate range) could equate to an amount of R2.54 million/annum. This potential saving in expenditure could be achieved if the installation configuration is optimized and a more accurate flow meter is utilized.

In conclusion, effective metering, quantification of losses, and strategic interventions are essential to mitigate water losses, enhance revenue collection, and ensure sustainable water management in developing countries like South Africa.



The WMCURVC procedure simplifies the process although providing a comprehensive approach that could be used to test an installation and assess flow meter installation accuracy. Using the Volumetric Evaluation Tool offers a systematic approach for assessing the accuracy of in-situ flow meter installations and determining the potential economic impact.



## 9. REFERENCES

Alfanda, A.M. & Farouk, A.I. 2017. Comparative Analysis of Circular and Rectangular Reinforced Concrete Tanks Based on Economical Design Perspective. *American Journal of Applied Scientific Research*, 3(2), p. 14.

American Water Works Association. 1962. *Water Meters: Selection, Installation, Testing, and Maintenance*. s.l.:American Water Works Association.

American Water Works Association. 2018. *Flowmeters in Water Supply*. 3<sup>rd</sup> ed. Denver: American Water Works Association.

Arregui, F., Cabrera, E., Cobacho, R. & García-Serra, J. 2006. Reducing Apparent Losses Caused By Meters Inaccuracies. *Water Practice & Technology*, Volume 1.

Arregui, F., Cabrera, E. J. & Cobacho, R. 2006. *Integrated Water Meter Management*. London: IWA Publishing.

Arregui, F., Gavara, F., Soriano, J. & Pastor-Jabaloyes, L. 2018. Performance Analysis of Ageing Single-Jet Water Meters for Measuring Residential Water Consumption. *Water*, 10(5), p. 612.

Azo Materials. 2018. *Water Flow Meters – How They Work*. [Online] Available at: <https://www.azom.com/article.aspx?ArticleID=15058> [Accessed 24 October 2020].

Baker, R.C. 2016. *Flow measurement handbook: industrial designs, operating principles, performance, and applications*. 2<sup>nd</sup> ed. New York: Cambridge University Press.

Beardsley, J.C. 2017. The use of water meters. *Journal-American Water Works Association*, 109(3), pp. 54-57.

Betta, V., Cascetta, F. & Palombo, A. 2002. Cold potable water measurement by means of a combination meter. *Measurement*, 32(3), pp. 173-179.

Brandt, M.J., Johnson, M.K., Elphinston, A.J. & Ratnayaka, D.D. 2017. Chapter 18 – Valves and Meters. In: M. J. Brandt, M. K. Johnson, A. J. Elphinston & D. D. Ratnayaka, eds. *Twort's Water Supply (Seventh Edition)*. Boston: Butterworth-Heinemann, pp. 743-775.

Buenfil, M. 2005. Water Meter. In: J. H. Lehr & J. Keeley, eds. *Water Encyclopedia*. 1 ed. s.l.: Wiley.



Jeremy Cape, J., Cook, B., Currey, A., Hassanli, A., Pezzaniti, D. & Turrall, H. 2008. Measured in-situ Verification of Meters for Non-Urban Water Supply, s.l.: Australian Government National Water Commission.

FlowMetrics Inc. 2017. Exploring the Different Types of Water Meters. [Online] Available at: <https://flowmetrics.com/exploring-types-water-meters/> [Accessed 18 October 2020].

Fontanazza, C.M., Notaro, V., Puleo, V. & Freni, G. 2013. Effects of network pressure on water meter under-registration: an experimental analysis. *Drinking Water Engineering and Science Discussions*, Volume 6, pp. 119-149.

Frenzel, F. 2011. *Industrial flow measurement Basics and practice*. s.l.: ABB Automation Products GmbH.

IHE Delft, 2013. Asset management - O&M. [Online] Available at: <https://bewop.un-ihе.org/node/46> [Accessed 16 October 2020].

Johnson, E. H. 1999. In situ calibration of large water meters. *Water SA*.

Larraona, G.S., Rivas, A. & Ramos, J.C. 2008. Computational Modeling and Simulation of a Single-Jet Water Meter. *Journal of Fluids Engineering*, 130(5).

Li, X.J. & Chong, P.H. 2019. Design and Implementation of a Self-Powered Smart Water Meter. *Sensors*, Volume 19.

Malunga, M. 2017. *Advanced water metering and its application in low income communities*, University of Cape Town.

Ministry of Housing and Urban Affairs, 2020. *Advisory on Water Meters, Instrumentation & SCADA*, New-Delhi: Government of India.

Ncube, M. & Akpofure, T. 2019. Assessment of apparent losses due to meter inaccuracy – a comparative approach. *Water SA*, Volume 45.

Ngabirano, L. 2017. *Case study review of advanced water metering applications in South Africa*, s.l.: University of Cape Town.

Palau, C.V.; Balbastre, I.; Manzano, J.; Azevedo, B.M.; Bomfim, G.V. 2019. Numerical Analysis of Woltman Meter Accuracy under Flow Perturbations. *Water*, Volume 11, p. 2622. <https://doi.org/10.3390/w11122622>



Palau, C.V.; Balbastre, I.; Manzano, J.; Azevedo, B.M.; Bomfim, G.V. 2018. Metrological behaviour of bulk water meters under diverse installation configurations. *Engenharia Agrícola*, 38(6), pp. 893-900.

Pereira, M. 2009. Flow meters: Part 1. *IEEE Instrumentation & Measurement Magazine*, 12(1), pp. 18-26.

UNIDO. 2019. *Guidelines on Calibration of Flow Meters*, s.l.: UNIDO.

Van Zyl, J.E. 2011. *Introduction to Integrated Water Meter Management*. WRC Report No TT490/11. Water Research Commission, Pretoria. [Online] Available at: <https://www.wrc.org.za/wp-content/uploads/mdocs/TT%20490-11.pdf>

Yoder, J. 2015. *Flowmeter Calibration & Recalibration...What You Should Know*. [Online] Available at: <https://www.piprocessinstrumentation.com/instrumentation/flow-measurement/article/15562783/flowmeter-calibration-recalibrationwhat-you-should-know>

Zenner. 2004. *Bulk Water Meters*. [Online] Available at: [https://www.zenner.com/files/content/ZENNER%20COM%20ENGLISCH/Downloads/CAT\\_Bulk-water-meters\\_EN.pdf](https://www.zenner.com/files/content/ZENNER%20COM%20ENGLISCH/Downloads/CAT_Bulk-water-meters_EN.pdf) [Accessed 19 November 2020].

Zhen, W. & Tao, Z. 2008. Computational study of the tangential type turbine flowmeter. *Flow Measurement and Instrumentation*, 19(5), pp. 233-239.

Zuzunaga, A. J. & Maron, B. 2013. A survey of non-invasive and semi-invasive flow meters for mining applications: Understanding and selecting the right technology for the application.









## **APPENDIX A**

### **Pierre van Ryneveld Reservoir Complex – Test setup**



**Table A-1: Pierre van Ryneveld reservoir complex**

Reservoirs	<div style="display: flex; justify-content: space-around;"> <div style="text-align: center;"> <p>7.6 MI</p>  </div> <div style="text-align: center;"> <p>15 MI</p>  </div> </div>
Chamber A	<div style="display: grid; grid-template-columns: 1fr 1fr; gap: 10px;"> <div style="text-align: center;">  <p>Ultrasonic clamp-on flow meter</p> </div> <div style="text-align: center;">  </div> <div style="text-align: center;">  <p>A-FM (128)</p> </div> <div style="text-align: center;">  <p>A-PRV (1)</p> </div> </div>



Chamber B



Chamber C

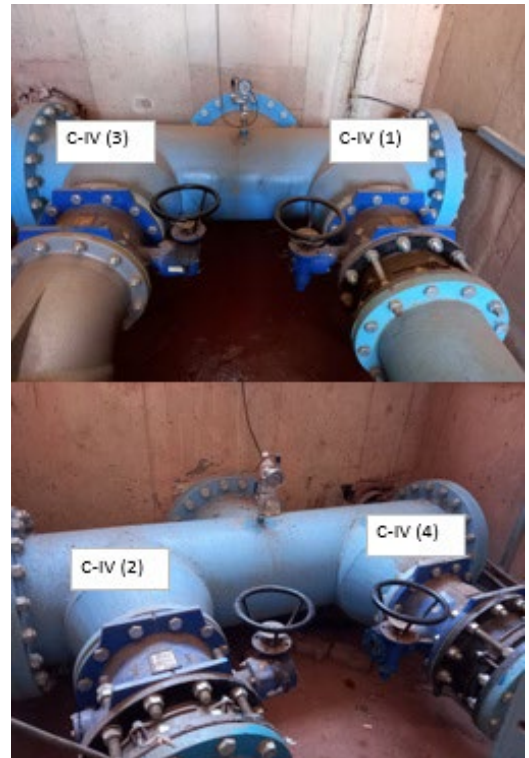
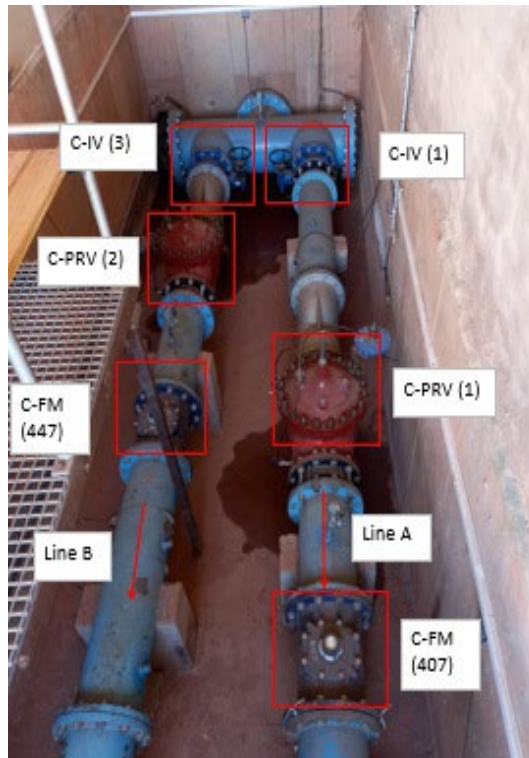

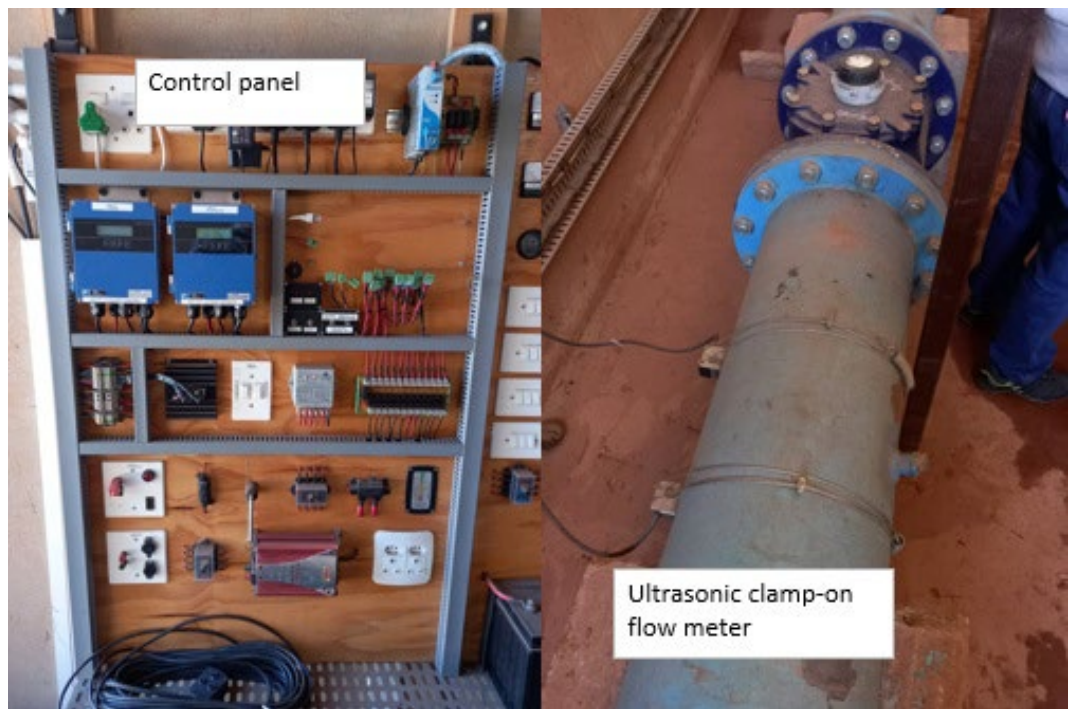

Chamber D



Chamber E

